

M A N E T A S

Y MANILLONES

Catálogo 2024



 **MENGUAL**

Pasión por lo que hacemos

Compromisos que nos mueven

Facilitar herrajes para interiorismo y carpintería gracias a un catálogo y una web que permiten concentrar todas las necesidades de los profesionales que confían en nosotros.

Pretendemos ofrecer unos plazos de **entrega inmediata** comprando justo lo que se necesita en cada momento.

Presentarnos cómo un proveedor único y fiable, pero sobre todo, con el afán de ofrecer constantemente las **novedades y tendencias internacionales** más relevantes, siendo un partner que les ayude a estar en la **vanguardia del interiorismo**.

PEDIDOS Online  www.mengual.com



Decor
Pág. 5



Hábitat
Pág. 45



Estilos
Pág. 79



Forja
Pág. 123



Técnica
Pág. 135

Descubre en un solo catálogo todas las novedades y tendencias en manillas para puertas de paso y correderas con el fin de que tus proyectos de interiorismo permitan que los detalles sean los que marquen la diferencia.



Basic
Pág. 147



Correderas
Pág. 151



Herrajes
Pág. 185



DECOR

SELEC®

Luxury Lever Handle

El modelo Iconic de SELEC se caracteriza por su marcado grabado que le aporta un carácter en perfecta armonía con las tendencias actuales.

De formas angulosas esta gama de manetas y asas cuenta con la superficie distintiva con patrón de diamantes que le aseguran un agarre excepcionalmente bueno.





ICONIC
By Selec D&D
Acero Inox

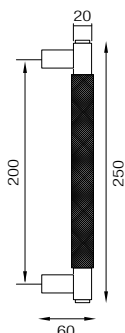

Garantía



Inox Mate 5
Negro Mate 5
PVD Oro Mate 5

41.0106.7
41.0108.9
41.0107.8

Manillón
Doble sin roseta
200
41.0113.3
41.0115.5
41.0114.4

Serreta
Ø54 mm.
41.0110.0
41.0112.2
41.0111.1

Mult.+Desb.
Ø54 mm.
41.0116.6
41.0118.8
41.0117.7

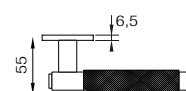
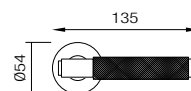

Uso intenso: Alta frecuencia de uso y probabilidad de uso indebido. Edificios públicos e institucionales; bibliotecas, hospitales y escuelas.
Durabilidad: 200.000 ciclos.
Resistencia al fuego: No.
Resistencia a la corrosión: Muy alta (240 h).

WAVE

Nace una manilla que
une empuñadura y cierre

Lineal, plana, esencial.

De diseño minimalista ha llegado para ampliar los horizontes del diseñador de interiores.

Conserva todas las funciones de una manilla tradicional: abre y cierra la puerta de un modo ergonómico ya sea de paso o corredera.

Una manilla que con la puerta abierta se integra perfectamente en la hoja ya que no sobresale dejando de ser un obstáculo para los que pasan cerca.

Descúbreala en la página **161**



Ciega



Baño



Cilindro

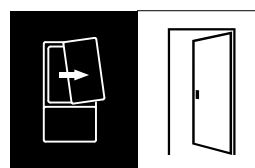

Puerta de paso
Wave Móvil

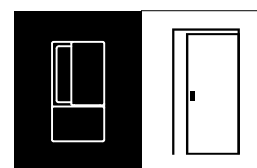

Puerta corredera
Wave Fija

ARETÈ FINE
By Mauro Ronchi
Latón

dnd



	Garantía	Serreta	Borjas	Mult.+Desb.
1/15				
Cromo Mate	4 años	41.5878.4	41.5946.2	41.5947.3
Cromo Brillo	4 años	41.5879.5	41.5948.4	41.5949.5
PVD Antracita	5 años	41.6238.0	41.6245.0	41.6246.1

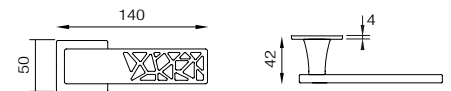

3

EN1906

200.000

EN1634-2

GARANTÍA 10 AÑOS

Uso intenso: Alta frecuencia de uso y probabilidad de uso indebido. Edificios públicos e institucionales; bibliotecas, hospitales y escuelas. | **Durabilidad:** 200.000 ciclos. | **Resistencia al fuego:** Si. **Resistencia a la corrosión:** 4 Muy alta (240 h). / 5 Extremadamente Alta (1.500 h).

EN1906 3 7 - 2 0 0 0 B Certificado con sistema de roseta VIS de 7 mm. **P** Bajo pedido.

dnd

Una manilla basada en la fusión de fundamental de aspectos ergonómicos con un diseño visual discreto, suave y sinuoso.

Viva! se ve diferente en función del punto de vista del espectador.

Lo que permanece constante es la sensación táctil de agarrar una maneta que se nota resistente y sustancial en la mano, gracias a su material sólido y elegante; el Latón.



Luca Nichetto
Diseñador Industrial





VIVA! FINE
By Luca Nichetto
Latón



Garantía



Grisans



Serreta



Borjas



Mult.+Desb.



	4	10					
Cromo Mate	4	10	41.0070.4	P 41.0078.1	41.6001.1	41.6002.2	41.5999.6
Cuero Latón patinado	4	10	41.0069.3	P 41.0077.0	P 41.0306.9	P 41.0305.8	P 41.0308.0
PVD Antracita	5	10	P 41.0072.6	P 41.0080.3	41.6684.5	P 41.6685.6	41.6678.6
PVD Níquel Brillo	4	10	P 41.7012.2	P 41.0079.2	41.6686.0	P 41.6687.1	P 41.6679.0
PVD Oro Antiguo Brillo	5	10	P 41.0073.7	P 41.0081.4	P 41.6688.2	P 41.6689.3	P 41.6681.2
PVD Oro Antiguo Mate	5	10	P 41.0074.8	P 41.0082.5	41.6690.4	P 41.6691.5	41.6682.3
PVD Cobre Mate	5	10	P 41.0075.9	P 41.0083.6	P 41.6692.6	P 41.6693.0	P 41.6683.4

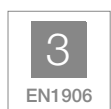
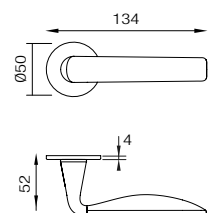
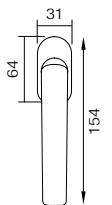

Uso intenso: Alta frecuencia de uso y probabilidad de uso indebido. Edificios públicos e institucionales; bibliotecas, hospitales y escuelas. | **Durabilidad:** 200.000 ciclos. | **Resistencia al fuego:** Si.

Resistencia a la corrosión: 4 Muy alta (240 h). / 5 Extremadamente Alta (1.500 h).

EN1906 3 7 - 2 0 0 0 B Certificado con sistema de roseta VIS de 7 mm.

M A N E T A S

Y MANILLONES

Catálogo 2024



 **MENGUAL**

Pasión por lo que hacemos

Compromisos que nos mueven

Facilitar herrajes para interiorismo y carpintería gracias a un catálogo y una web que permiten concentrar todas las necesidades de los profesionales que confían en nosotros.

Pretendemos ofrecer unos plazos de **entrega inmediata** comprando justo lo que se necesita en cada momento.

Presentarnos cómo un proveedor único y fiable, pero sobre todo, con el afán de ofrecer constantemente las **novedades y tendencias internacionales** más relevantes, siendo un partner que les ayude a estar en la **vanguardia del interiorismo**.

PEDIDOS Online  www.mengual.com



Decor
Pág. 5



Hábitat
Pág. 45



Estilos
Pág. 79



Forja
Pág. 123



Técnica
Pág. 135

Descubre en un solo catálogo todas las novedades y tendencias en manillas para puertas de paso y correderas con el fin de que tus proyectos de interiorismo permitan que los detalles sean los que marquen la diferencia.



Basic
Pág. 147



Correderas
Pág. 151



Herrajes
Pág. 185

dnd

EDRA-02 FINE

By Mauro Ronchi
Latón

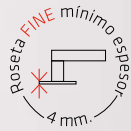

Ejemplo de montaje con placa
Cód. 4140536



1

Garantía



Serreta



Borjas



Mult.+Desb.



Cromo Mate
Cromo Brillo
Negro Mate
PVD Antracita

4 10
4 10
4 10
5 10

41.5873.6
P 41.5874.0
N 41.6929.7
41.6237.6

41.5946.2
41.5948.4
N 41.7927.4
41.6245.0

N 41.5947.3
41.5949.5
P N 41.7928.5
41.6246.1

41.5935.5
41.5936.6
N 41.7929.6
41.6242.4

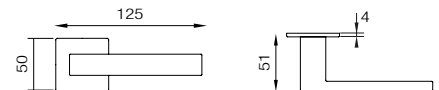

Uso inteno: Alta frecuencia de uso y probabilidad de uso indebido. Edificios públicos e institucionales; bibliotecas, hospitales y escuelas. | **Durabilidad:** 200.000 ciclos. | **Resistencia al fuego:** Si.

Resistencia a la corrosión: 4 Muy alta (240 h). / 5 Extremadamente Alta (1.500 h).

EN1906 3 7 - 2 0 0 0 B Certificado con sistema de roseta VIS (7 mm). P Solo bajo pedido.

dnd

BOOLE FINE
By Odo Fioravanti
Latón



1

Garantía



Cromo Mate
Cromo Brillo
Negro Mate

10
10
5

P 41.6617.1
P 41.6618.2
P 41.6616.0

41.6001.1
41.6003.3
41.6470.1

41.6002.2
41.6004.4
41.6469.0

41.5999.6
P 41.6000.0
P 41.6680.1

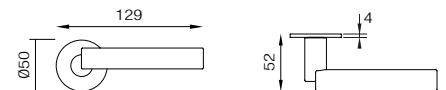

3
EN1906

200.000

EN1634-2

GARANTÍA 5 AÑOS
GARANTÍA 10 AÑOS

Uso intenso: Alta frecuencia de uso y probabilidad de uso indebido. Edificios públicos e institucionales; bibliotecas, hospitales y escuelas. **Durabilidad:** 200.000 ciclos. | **Resistencia al fuego:** Si. **Resistencia a la corrosión:** Muy alta (240 h).

EN1906 3 7 - 2 0 0 0 B

Certificado con sistema de roseta VIS (7 mm). **P** Solo bajo pedido.

dnd



Giulio Iacchetti
Diseñador Industrial



Ginkgo toma su forma gracias a la inspiración proveniente de la naturaleza.

La forma única de la hoja del ginkgo, árbol de los cuarenta escudos o nogal del Japón es un árbol único en el mundo sin parientes vivos, inspira esta maneta convirtiéndose en la estructura y decoración de una maneta muy especial que se produce en dos versiones diferentes.



Good Design Awards
2017

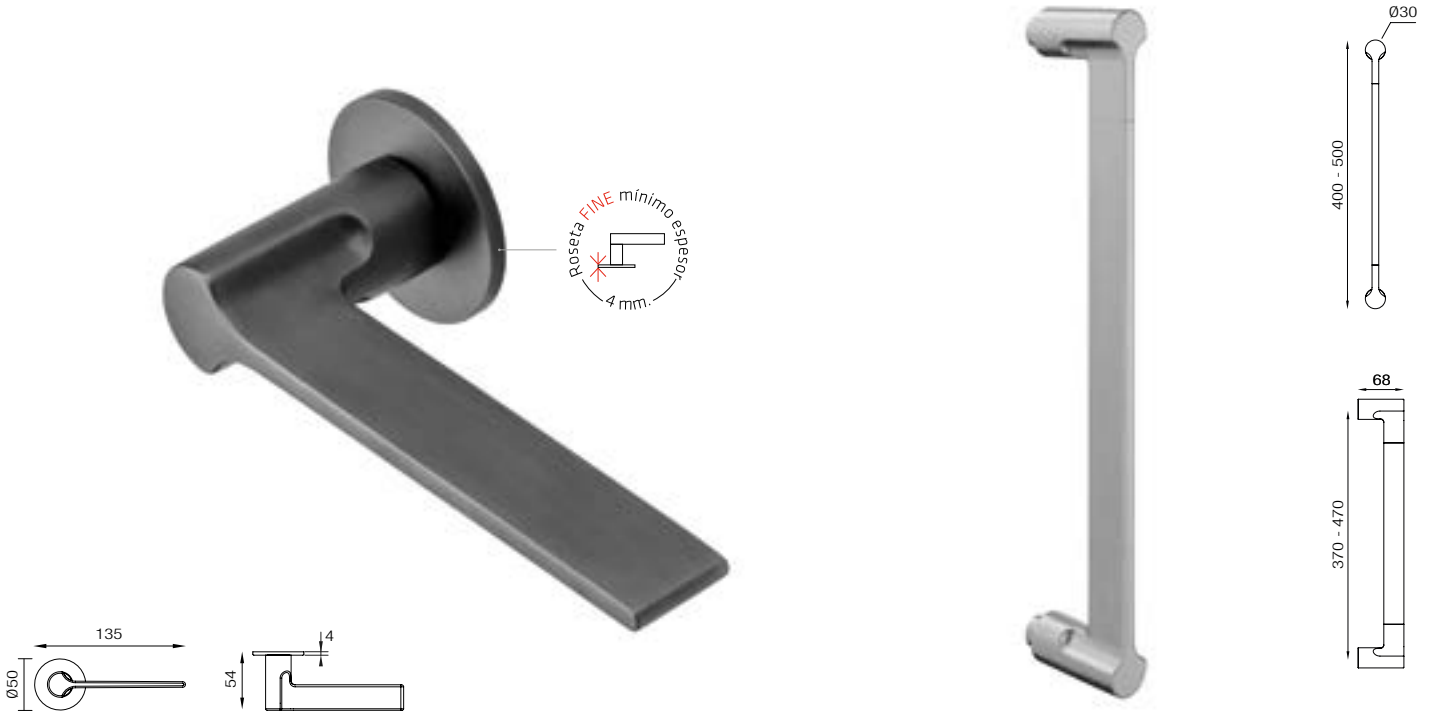

GINKGO FINE

By Giulio Iacchetti
Latón

Embalaje	Garantía	Manillones Simples	Manillones Dobles		Serreta	Borjas	Mult.+Desb.		
			370	470					
1									
Cromo Mate	4 10	41.6619.3	P 41.0036.3	P 41.0042.9	P 41.0039.6	P 41.0046.2	41.6001.1	41.6002.2	41.5999.6
Negro Mate	4 10	N 41.6926.4					N 41.0229.9	N 41.0231.0	P 41.6680.1
PVD Níquel Brillo	5 10	P 41.6620.4	P 41.0037.4	P 41.0044.0	P 41.0040.7	P 41.0047.3	41.6686.0	P 41.6687.1	P 41.6679.0
PVD Antracita	5 10	41.6621.5	P 41.0038.5	P 41.0045.1	P 41.0041.8	P 41.0048.4	41.6684.5	P 41.6685.6	41.6678.6
PVD Oro Antiguo Mate	5 10	N 41.6928.6					41.6690.4	41.6691.5	41.6682.3
PVD Oro Antiguo Brillo	5 10	P N 41.6927.5					41.6688.2	41.6689.3	41.6681.2

3 EN1906	 200.000	 EN1634-2	 GARANTÍA 10 AÑOS
--------------------	-------------	--------------	----------------------

Uso intenso: Alta frecuencia de uso y probabilidad de uso indebido. Edificios públicos e institucionales; bibliotecas, hospitales y escuelas. | **Durabilidad:** 200.000 ciclos. | **Resistencia al fuego:** Si.
Resistencia a la corrosión: 4 Muy alta (240 h). / 5 Extremadamente Alta (1.500 h).

EN1906 3 7 - 2 0 0 0 B Certificado con sistema de roseta VIS (7 mm). P Solo bajo pedido.

dnd

Una forma de inspiración natural, como la hermosa hoja del Ginkgo, se convierte en la estructura y decoración de una manilla disponible en dos versiones diferentes. Ginkgo está disponible en seis acabados. En el año 2017, Ginkgo se adjudicó el premio Good Design en la categoría de Hardware.



Giulio Iacchetti
Diseñador Industrial



Good Design Awards
2017

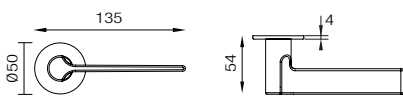
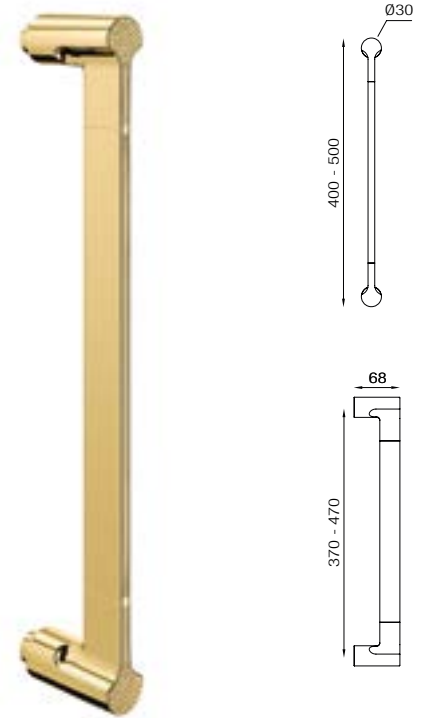

GINKGO BILOBA FINE

Giulio Iacchetti

Latón

	Garantía		Manillones Simples		Manillones Dobles		Serreta	Borjas	Mult.+Desb.	
PVD Niquel Brillo	4	10	P 41.6622.6	P 41.0049.5	P 41.0056.1	P 41.0052.8	P 41.0059.4	41.6686.0	P 41.6687.1	P 41.6679.0
PVD Oro Antiguo Brillo	5	10	P 41.6623.0	P 41.0050.6	P 41.0057.2	P 41.0053.9	P 41.0060.5	P 41.6688.2	P 41.6689.3	P 41.6681.2
PVD Oro Antiguo Mate	5	10	P 41.6624.1	P 41.0051.7	P 41.0058.3	P 41.0055.0	P 41.0061.6	41.6690.4	P 41.6691.5	41.6682.3

3

EN1906

200.000

EN1634-2

GARANTÍA 10 AÑOS

Uso inteno: Alta frecuencia de uso y probabilidad de uso indebido. Edificios públicos e institucionales; bibliotecas, hospitales y escuelas. | **Durabilidad:** 200.000 ciclos. | **Resistencia al fuego:** Si.

Resistencia a la corrosión: 4 Muy alta (240 h). / 5 Extremadamente Alta (1.500 h).

EN1906 3 7 - 2 0 0 0 0 B Certificado con sistema de roseta VIS (7 mm). **P** Solo bajo pedido.



Seleccionado
ADI DESIGN 2019



Importante: Para placas sin muelle se precisa instalar picaportes reforzados.

dnd

Un modelo de manilla disponible en diferentes soluciones. La roseta pasa a representar un elemento mínimo que, además, se inserta en la base de la maneta. El gesto de abrir una puerta representa un hilo conductor invisible que de forma inconsciente, nos adentra en el mundo de la habitación que se abre paso ante nuestros ojos o que dejamos atrás.

(IN)finito ha sido diseñada por el arquitecto Alfonso Femia y seleccionada para su publicación en el ADI Design Index 2019.



Alfonso Femia
Arquitecto



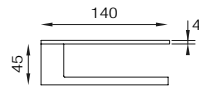
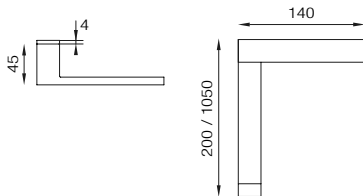
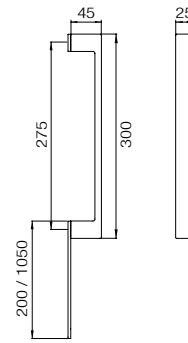

(IN)FINITO FINE

By Alfonso Femia

Latón

	Placa ciega	Placa bocallave serreta	Placa mult.+desb.	Roseta H ciega	Roseta H + bocallave serreta	Roseta H + mult.+desb.
1						
Cromo Mate	10 P 41.6660.2	P 41.6663.5	P 41.6661.3	P 41.6664.6	P 41.6662.4	P 41.6665.0
Negro Mate	5 P 41.6666.1	P 41.6669.4	P 41.6667.2	P 41.6670.5	P 41.6668.3	P 41.6671.6
Latón Mate	5 P 41.6672.0	P 41.6675.3	P 41.6673.1	P 41.6676.4	P 41.6674.2	P 41.6677.5
				P 41.0235.4	P 41.0238.7	P 41.0242.0
				P 41.0236.5	P 41.0239.8	P 41.0243.1
				P 41.0237.6	P 41.0240.9	P 41.0244.2

	Manillones Simples			Manillones Dobles		
1						
Cromo Mate	10 P 41.0245.3	P 41.0251.9	P 41.0266.2	P 41.0248.6	P 41.0262.9	P 41.0269.5
Negro Mate	5 P 41.0246.4	P 41.0260.7	P 41.0267.3	P 41.0249.7	P 41.0264.0	P 41.0270.6
Latón Mate	5 P 41.0247.5	P 41.0261.8	P 41.0268.4	P 41.0250.8	P 41.0265.1	P 41.0271.7

3

EN1906

200.000

EN1634-2

GARANTIA 5 AÑOS

GARANTIA 10 AÑOS

Uso inteso: Alta frecuencia de uso y probabilidad de uso indebido. Edificios públicos e institucionales; bibliotecas, hospitales y escuelas. **Durabilidad:** 200.000 ciclos. | **Resistencia al fuego:** Si. **Resistencia a la corrosión:** Muy alta (240 h).

EN1906 3 7 - 2 0 0 0 B

dnd

Levante es una manilla en la que los bordes, las curvas y los grosores han sido diseñados con la intención de lograr la esencialidad de una forma estilizada y sencilla que caracteriza un objeto cuyo diseño se identifica con su función.

Este proyecto surge del cruce de caminos entre un diseñador y un arquitecto, así como del deseo de este último de arriesgar en un tema, aparentemente sencillo pero complejo en realidad, como lo es el diseño de manillas.





Maurizio Varratta
Arquitecto





LEVANTE FINE
By Maurizio Varratta
Latón

	Garantía	Serreta	Borjas	Mult.+Desb.	
 1					
Cromo Mate	4 10	41.6656.5	41.6001.1	41.6002.2	41.5999.6
PVD Antracita	5 10	41.6657.6	41.6684.5	P 41.6685.6	41.6678.6
PVD Oro Antiguo Mate	5 10	41.6658.0	41.6690.4	P 41.6691.5	41.6682.3
PVD Cobre Mate	5 10	P 41.6659.1	P 41.6692.6	P 41.6693.0	P 41.6683.4

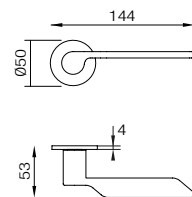

3
EN1906

200.000



EN1634-2

GARANTÍA 10 AÑOS

Uso intenso: Alta frecuencia de uso y probabilidad de uso indebido. Edificios públicos e institucionales; bibliotecas, hospitales y escuelas. | **Durabilidad:** 200.000 ciclos. | **Resistencia al fuego:** Si.

Resistencia a la corrosión: **4** Muy alta (240 h). / **5** Extremadamente Alta (1.500 h).

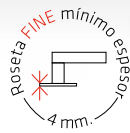
EN1906 **3** **7** - **2** **0** **0** **0** **B** Certificado con sistema de roseta VIS (7 mm). **P** Solo bajo pedido.



SIKE FINE



Ejemplo de montaje con placa
Cód. 41.4051.4

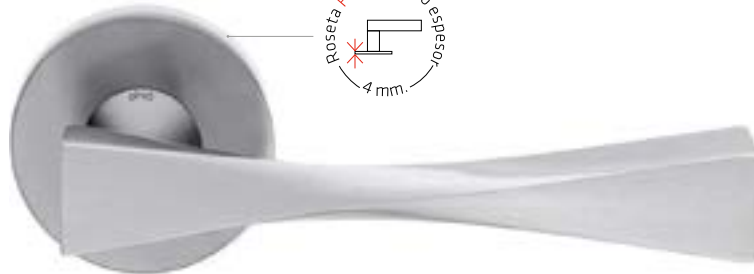
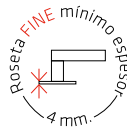

TWIST FINE

dnd

SIKE FINE

By Karim Rashid
Latón

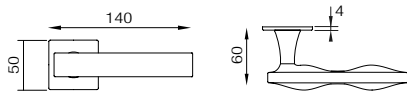

1 Garantía

SIKE FINE Serreta Borjas Mult.+Desb.



Cromo Mate	10	P 41.5894.6	41.5946.2	41.5947.3	41.5935.5
Cromo Brillo	10	P 41.5895.0	41.5948.4	41.5949.5	41.5936.6

TWIST FINE

By Karim Rashid
Latón

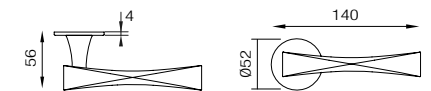

1 Garantía

TWIST FINE Serreta Borjas Mult.+Desb.



Cromo Mate	10	P 41.5882.1	41.6001.1	41.6002.2	41.5999.6
------------	----	-------------	-----------	-----------	-----------

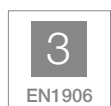

Uso intenso: Alta frecuencia de uso y probabilidad de uso indebido. Edificios públicos e institucionales; bibliotecas, hospitales y escuelas. **Durabilidad:** 200.000 ciclos. | **Resistencia al fuego:** Si.
Resistencia a la corrosión: Muy alta (240 h).

EN1906 3 7 - 2 0 0 0 B Certificado con sistema de roseta VIS (7 mm). P Solo bajo pedido.



dnd

LUXURY FINE

By Mauro Ronchi

Latón

Roseta VIS mínimo espesor
4 mm.



Ejemplo de montaje con placa
Cód. 41.4053.6



Cromo Brillo

Garantía

10



P 41.5886.5

Serreta



41.6003.3

Borjas



41.6004.4

Mult.+Desb.



P 41.6000.0

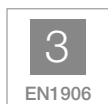
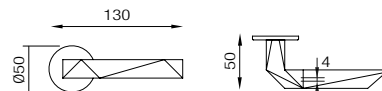

EN1906



200.000



EN1634-2



GARANTIA 10 AÑOS

Uso inteno: Alta frecuencia de uso y probabilidad de uso indebido. Edificios públicos e institucionales; bibliotecas, hospitales y escuelas. **Durabilidad:** 200.000 ciclos. | **Resistencia al fuego:** Si. **Resistencia a la corrosión:** Muy alta (240 h).

EN1906 3 7 - 2 0 0 0 B Certificado con sistema de roseta VIS (7 mm). P Solo bajo pedido.

dnd

Esta maneta con un cuidado diseño la componen dos rasgos gráficos imprescindibles; una línea y un círculo que se cruzan de forma central y simétrica. Timeless está disponible en cinco acabados diferentes: plata, oro satinado, bronce, blanco, negro.



Marco Pisati
Arquitecto y Diseñador industrial





TIMELESS

By Marco Pisati
Aluminio

	Garantía	Serreta	Borjas	Mult.+Desb.	
1					
Cromo Mate	5	41.6451.3	41.6459.4	41.6463.1	41.6455.0
Negro	5	41.6467.5	41.6470.1	41.6469.0	41.6468.6
Blanco	5	41.6484.1	41.6487.4	41.6486.3	41.6485.2
Oro Mate	5	P 41.6453.5	P 41.6461.6	P 41.6465.3	P 41.6457.2
Bronce Moka	5	P 41.6454.6	P 41.6462.0	P 41.6466.4	P 41.6458.3

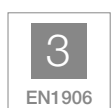
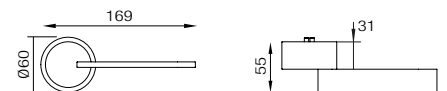

Uso intenso: Alta frecuencia de uso y probabilidad de uso indebido. Edificios públicos e institucionales; bibliotecas, hospitales y escuelas. **Durabilidad:** 200.000 ciclos. | **Resistencia al fuego:** No. | **Resistencia a la corrosión:** Muy alta (240 h).

EN1906 3 7 - 2 0 0 0 B

dnd

Volúmenes marcados y redondeados recuerdan la forma de los dirigibles Zeppelin de principios del siglo XX, con el fin de obtener una manilla contemporánea con una hábil realización técnica.



Jaime Hayón
Diseñador y artista



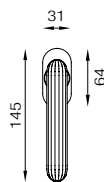

ZEPPELIN
By Jaime Hayon
Latón



Negro Mate
Verde
PVD Níquel Brillo
PVD Oro Antiguo Brillo

Garantía



Serreta

Borjas

Mult.+Desb.



P 41.6605.3

P 41.6609.0

41.6250.5

41.6251.6

41.6252.0

P 41.6606.4

P 41.6610.1

P 41.6719.5

P 41.6722.1

P 41.6725.4

P 41.6607.5

P 41.6611.2

P 41.6720.6

P 41.6723.2

P 41.6726.5

P 41.6608.6

P 41.6612.3

P 41.6721.0

P 41.6724.3

P 41.6727.6

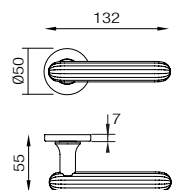

Uso intenso: Alta frecuencia de uso y probabilidad de uso indebido. Edificios públicos e institucionales; bibliotecas, hospitales y escuelas. | **Durabilidad:** 200.000 ciclos. | **Resistencia al fuego:** Si.
Resistencia a la corrosión: 4 Muy alta (240 h) / 5 Extremadamente Alta (1.500 h).

EN1906 3 7 - 2 0 0 0 B

dnd



Freely es una manilla sobria y de diseño esencial, que combina belleza y funcionalidad a través de una ergonomía perfecta. Con un delicado diseño se consigue una manilla no invasiva y cómoda.

Representa una reflexión abierta sobre el gesto de abrir una puerta, como respuesta a las necesidades más actuales relacionadas con seguridad y eficiencia. Su forma innovadora permite utilizarla de diferentes maneras, aprovechando su diseño que permite evitar el agarre tradicional a favor de toques alternativos, como apoyar el codo.

Este proyecto nace de la necesidad de buscar alternativas a las manillas convencionales y permitir el uso del codo como elemento activo en la apertura de la puerta.



Giulio Iacchetti
Diseñador Industrial





FREELY

By Giulio Iacchetti
Aluminio



1

Garantía



Serreta



Borjas



Mult.+Desb.



Cromo Mate

7

P 41.0232.1

41.4500.5

41.4501.6

41.5778.2

Negro Mate

7

P 41.0234.3

41.6250.5

41.6251.6

41.6252.0

Antracita

7

P 41.0233.2

P 41.0310.2

P 41.0311.3

P 41.0309.1

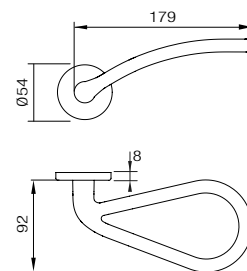

Uso intenso: Alta frecuencia de uso y probabilidad de uso indebido. Edificios públicos e institucionales; bibliotecas, hospitales y escuelas.

Durabilidad: 200.000 ciclos. | **Resistencia al fuego:** No. | **Resistencia a la corrosión:** Elevada (96 h).

EN1906 3 7 - 0 0 0 0 B

dnd

Pod es una manilla de líneas orgánicas pero también geométricas inspirada en el perfil de una delgada rama de árbol.

Creada mediante un proceso de fabricación delicado y original: una varilla se gira por cada extremo y se dobla cuidadosamente en un ángulo de 45°, haciendo un gesto dinámico y equilibrado en la barra horizontal de la palanca hasta conseguir su original y curiosa forma definitiva.









Holscher Design
Estudio de diseño multidisciplinar





POD FINE

by Holsher Design
Latón

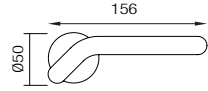
	Garantía	Manillón Simple	Manillón Doble	Serreta	Borjas	Muletilla	
 1							
Cromo Brillo	10	P 41.0272.8	P 41.0283.8	P 41.0289.3	41.6003.3	41.6004.4	P 41.0278.3
Cromo Mate	10	P 41.0273.9	P 41.0284.9	P 41.0290.4	41.6001.1	41.6002.2	P 41.0279.4
Negro Mate	5	P 41.0275.0	P 41.0286.0	P 41.0291.5	P 41.0229.9	P 41.0231.0	P 41.0280.5
PVD Oro Antiguo Brillo	10	P 41.0276.1	P 41.0287.1	P 41.0292.6	41.6690.4	41.6691.5	P 41.0281.6
PVD Oro Antiguo Mate	10	P 41.0277.2	P 41.0288.2	P 41.0293.7	41.6688.2	41.6689.3	P 41.0282.7

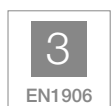

Uso intenso: Alta frecuencia de uso y probabilidad de uso indebido. Edificios públicos e institucionales; bibliotecas, hospitales y escuelas. | **Durabilidad:** 200.000 ciclos. | **Resistencia al fuego:** No.
Resistencia a la corrosión: Muy alta (240 h).

EN1906 3 7 - 2 0 0 0 B



dnd

MADELEINE FINE

By Inga Sempé
Latón

1

Garantía



Serreta



Borjas



Mult.+Desb.



Negro Mate

4 5

P 41.6613.4

41.6470.1

41.6469.0

P 41.6680.1

PVD Niquel Brillo

4 10

P 41.6614.5

41.6686.0

P 41.6687.1

P 41.6679.0

PVD Oro ant. Brillo

5 10

P 41.6615.6

P 41.6688.2

P 41.6689.3

P 41.6681.2

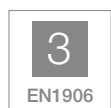
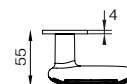

Uso intenso: Alta frecuencia de uso y probabilidad de uso indebido. Edificios públicos e institucionales; bibliotecas, hospitales y escuelas. | **Durabilidad:** 200.000 ciclos. | **Resistencia al fuego:** Si.
Resistencia a la corrosión: Extremadamente Alta (1.500 h).

EN1906 3 7 - 2 0 0 0 B

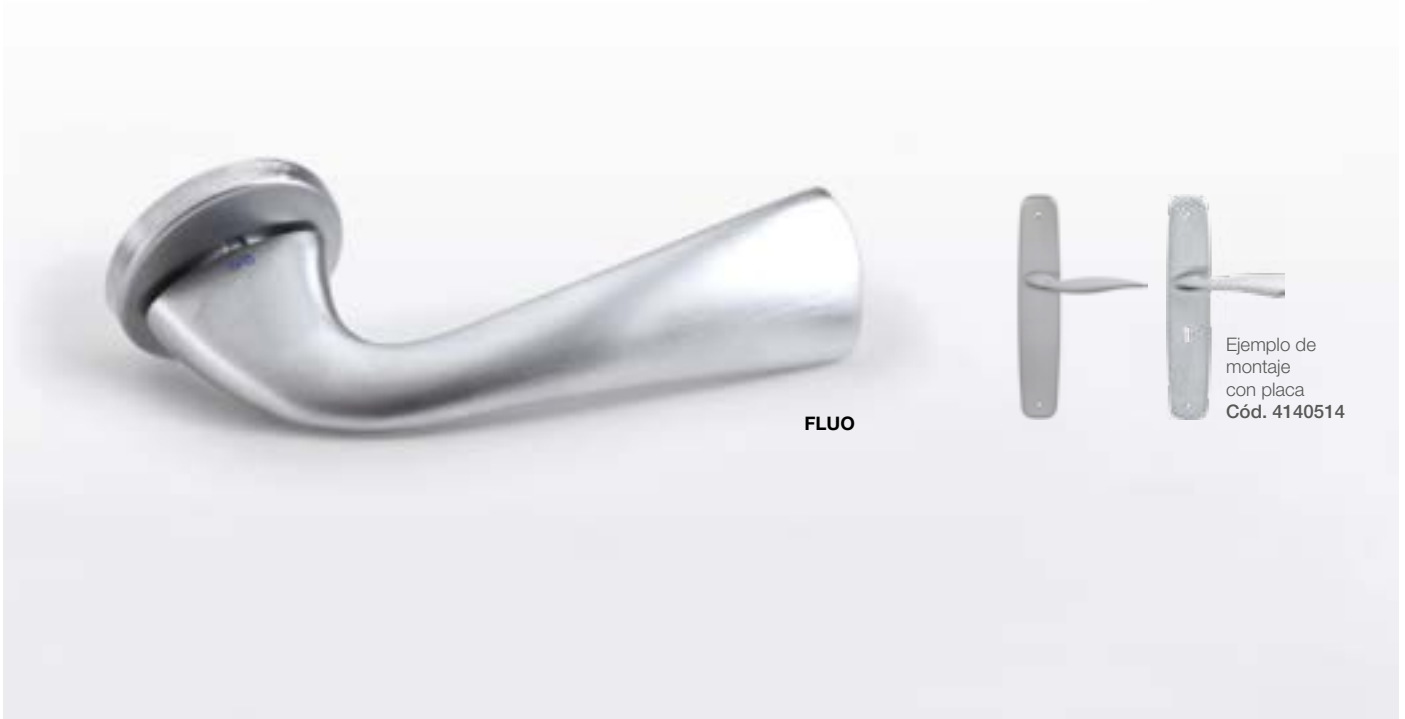

FLUO

Ejemplo de montaje con placa Cód. 4140514



GO

dnd

FLUO
By Mauro Ronchi
Latón

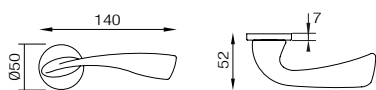

GO
By Mauro Ronchi
Latón

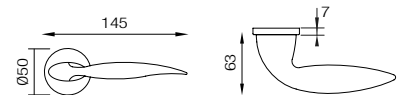

	FLUO	GO	Serreta	Borjas	Mult.+Desb.
Embalaje	1/4				
Garantía	10 años				
Cromo Mate	41.4557.6	41.4559.1	41.4500.5	41.4501.6	41.5778.2

3
EN1906

200.000

EN1634-2

GARANTÍA 10 AÑOS

Uso intenso: Alta frecuencia de uso y probabilidad de uso indebido. Edificios públicos e institucionales; bibliotecas, hospitales y escuelas.
Durabilidad: 200.000 ciclos. | **Resistencia al fuego:** Si. | **Resistencia a la corrosión:** Muy alta (240 h).

EN1906 **3 7 - 2 0 0 0 B**



dnd

ESA
By Mauro Ronchi
Aluminio / Zamak

	Garantía		Serreta	Borjas	Mult.+Desb.
📦 1					
Cromo Brillo - blanco	7	41.4530.0	41.4504.2	41.4502.0	41.5780.4
Cromo Brillo - negro	7	41.4531.1	41.4504.2	41.4502.0	41.5780.4
Cromo Brillo - cromo Mate	7	41.4529.6	41.4504.2	41.4502.0	41.5780.4

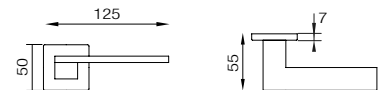

3
EN1906

200.000

GARANTÍA 7 AÑOS

Uso intenso: Alta frecuencia de uso y probabilidad de uso indebido. Edificios públicos e institucionales; bibliotecas, hospitales y escuelas. **Durabilidad:** 200.000 ciclos. | **Resistencia al fuego:** No. | **Resistencia a la corrosión:** Muy alta (240 h).







EN1906 3 7 - 0 0 0 0 B



Ejemplo de montaje con placa
Cód. 4140540

dnd

MÍNIMA
DND Technical Division
Aluminio / Zamak

 1	Garantía		Serreta 	Borjas 	Mult.+Desb. 
Cromo Brillo-Mate		41.5774.5	41.4498.3	41.4499.4	41.5777.1

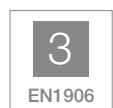
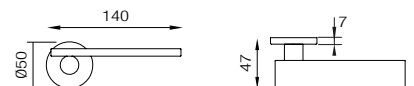

Uso intenso: Alta frecuencia de uso y probabilidad de uso indebido. Edificios públicos e institucionales; bibliotecas, hospitales y escuelas. **Durabilidad:** 200.000 ciclos. | **Resistencia al fuego:** No. | **Resistencia a la corrosión:** Muy alta (240 h).

EN1906 3 7 - 0 0 0 0 B



dnd

SHORT FINE

By Karim Rashid

Latón

1/12

Garantía



Serreta

Borjas

Mult.+Desb.



Cromo Mate	10	N 41.6922.0	41.6001.1	41.6002.2	41.5999.6
Negro Mate	10	N 41.6923.1	41.0229.9	N 41.0231.0	41.6680.1
PVD Antracita	10	N 41.6924.2	41.6684.5	41.6685.6	41.6678.6
PVD Oro antiguo Mate	10	N 41.6925.3	41.6690.4	41.6691.5	41.6682.3

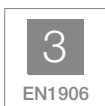
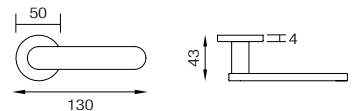

Uso intenso: Alta frecuencia de uso y probabilidad de uso indebido. Edificios públicos e institucionales; bibliotecas, hospitales y escuelas. **Durabilidad:** 200.000 ciclos. | **Resistencia al fuego:** Si. **Resistencia a la corrosión:** Muy alta (240 h).

EN1906 3 7 - 0 0 0 0 B

dnd

SHORT

By Karim Rashid
Latón



Karim Rashid
Karim Rashid



Ejemplo de montaje con placa
Cód. 4140514



Garantía



Cromo Mate 10
Brunito 2

41.5891.3
41.5892.4

41.4500.5
41.5940.3

41.4501.6
41.5941.4

41.5778.2
41.5932.2

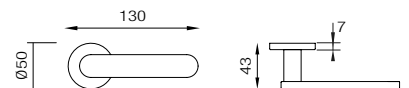

3

EN1906



200.000



EN1634-2



2 AÑOS

Uso intenso: Alta frecuencia de uso y probabilidad de uso indebido. Edificios públicos e institucionales; bibliotecas, hospitales y escuelas.

Durabilidad: 200.000 ciclos. | **Resistencia al fuego:** Si. | **Resistencia a la corrosión:** Muy alta (240 h).

EN1906 3 7 - 2 0 0 0 B



FLUKE

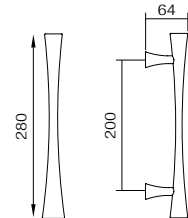

CHANGE



Ejemplo de montaje con placa
Cód. 4140514



dnd

FLUKE
By Karim Rashid
Latón

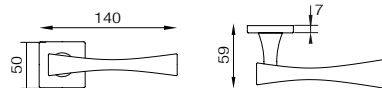

	Manillón	Serreta	Borjas	Mult.+Desb.
Garantía				
Cromo Mate	10 41.4552.1	41.4257.0	41.4505.3	41.4503.1
Cromo Brillo	10 P 41.5881.0	P 41.5898.3	41.4504.2	41.4502.0

CHANGE
By Sandro Santantonio
Latón

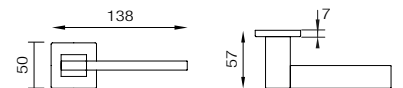

	Serreta	Borjas	Mult.+Desb.
Garantía			
Blanco	5 P 41.5887.6	41.5952.1	41.5953.2
Negro	5 41.5888.0	41.5954.3	41.5955.4

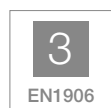

Uso intenso: Alta frecuencia de uso y probabilidad de uso indebido. Edificios públicos e institucionales; bibliotecas, hospitales y escuelas. **Durabilidad:** 200.000 ciclos. | **Resistencia al fuego:** Si.
Resistencia a la corrosión: Muy alta (240 h).

EN1906 3 7 - 2 0 0 0 B



HOLLY



Ejemplo de montaje con placa
Cód. 4140536



SOCHIC 02



dnd

HOLLY
DND Technical Division
Zamak

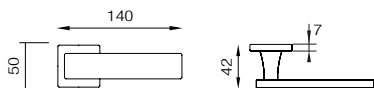

SOCHIC 02
DND Technical Division
Zamak

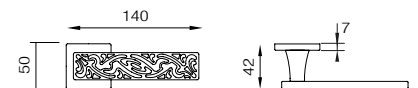

	HOLLY		SOCHIC 02	Serreta	Borjas	Mult.+Desb.
1						
Garantía						
Cromo Mate	4	10	P 41.5871.4	41.4505.3	41.4503.1	41.5779.3
Cromo Brillo	4	10	41.5872.5	41.4504.2	41.4502.0	41.5780.4
Oro 24K	2	3	P 41.5884.3	41.5950.6	P 41.5951.0	P 41.5937.0

3
EN1906

200.000

3 AÑOS GARANTÍA

10 AÑOS GARANTÍA

Uso intenso: Alta frecuencia de uso y probabilidad de uso indebido. Edificios públicos e institucionales; bibliotecas, hospitales y escuelas. **Durabilidad:** 200.000 ciclos. | **Resistencia al fuego:** No.
Resistencia a la corrosión: 2 Moderada (48 h). / 4 Muy alta (240 h).

EN1906 3 7 - 0 0 0 0 B



LINEAR



Ejemplo de montaje con placa
Cód. 4140514



DOLCE



dnd

LINEAR
By Mauro Ronchi
Latón

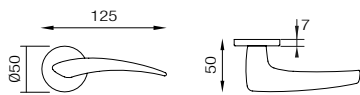

DOLCE
By Mauro Ronchi
Latón

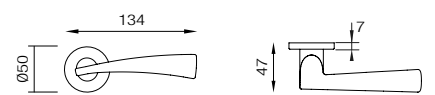



	LINEAR	DOLCE	Manillón	Serreta	Borjas	Mult.+Desb.
1						
Cromo Mate	10 41.4560.2	41.4556.5	P 41.3415.5	41.4500.5	41.4501.6	41.5778.2
Cromo Brillo	10 P 41.5876.2	P 41.5877.3	P 41.5899.4	41.4498.3	41.4499.4	41.5777.1

3 EN1906	200.000	EN1634-2	GARANTÍA 10 AÑOS
--------------------	----------------	-----------------	-------------------------

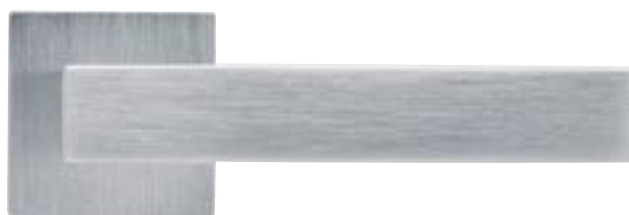
Uso intenso: Alta frecuencia de uso y probabilidad de uso indebido. Edificios públicos e institucionales; bibliotecas, hospitales y escuelas.
Durabilidad: 200.000 ciclos. | **Resistencia al fuego:** Si. | **Resistencia a la corrosión:** Muy alta (240 h).
 EN1906 **3 7 - 2 0 0 0 B**



ÁNGOLO
By Groël Studio
Latón

 1	Garantía		Serreta 	Borjas 	Mult.+Desb.  
Cromo Mate		41.5809.5	41.4505.3	41.4503.1	41.5779.3
Cromo Brillo		 41.5810.6	41.4504.2	41.4502.0	41.5780.4

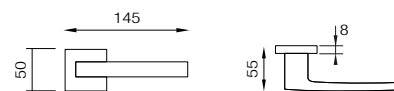

Uso intenso: Alta frecuencia de uso y probabilidad de uso indebido. Edificios públicos e institucionales; bibliotecas, hospitales y escuelas.
Durabilidad: 200.000 ciclos.
Resistencia al fuego: No.
Resistencia a la corrosión: Muy alta (240 h).



FILA



LOG-GIC



FILA
By Groël Studio
Latón

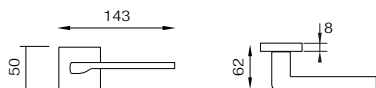

LOG-GIC
By Groël Studio
Latón

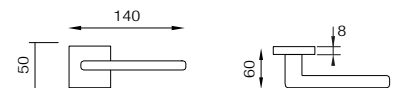

		FILA	LOG-GIC	Manillón	Serreta	Borjas	Mult.+Desb.
1	Garantía						
Cromo Mate	10	41.5787.4	41.5781.5	41.5840.1	41.4505.3	41.4503.1	41.5779.3
Negro	5	41.5788.5	41.5782.6	41.7930.7	41.5954.3	41.5955.4	41.5939.2
Blanco	5	41.5789.6		41.7931.8	41.5952.1	41.5953.2	41.5938.1



Uso intenso: Alta frecuencia de uso y probabilidad de uso indebido. Edificios públicos e institucionales; bibliotecas, hospitales y escuelas.
Durabilidad: 200.000 ciclos.
Resistencia al fuego: No.
Resistencia a la corrosión: Muy alta (240 h).



BACI
By Groël Studio
Latón

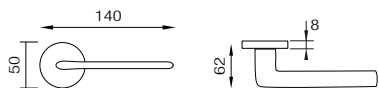

Garantía	Manillón	Serreta	Borjas	Mult.+Desb.
5 AÑOS	Manillón	Serreta	Borjas	Mult.+Desb.
5 AÑOS	Manillón	Serreta	Borjas	Mult.+Desb.
5 AÑOS	Manillón	Serreta	Borjas	Mult.+Desb.
10 AÑOS	Manillón	Serreta	Borjas	Mult.+Desb.
20 AÑOS	Manillón	Serreta	Borjas	Mult.+Desb.
20 AÑOS	Manillón	Serreta	Borjas	Mult.+Desb.
20 AÑOS	Manillón	Serreta	Borjas	Mult.+Desb.

200.000

5 AÑOS GARANTÍA

10 AÑOS GARANTÍA

20 AÑOS GARANTÍA

Uso intenso: Alta frecuencia de uso y probabilidad de uso indebido. Edificios públicos e institucionales; bibliotecas, hospitales y escuelas. **Durabilidad:** 200.000 ciclos. | **Resistencia al fuego:** No. | **Resistencia a la corrosión:** Muy alta (240 h).

EN1906 3 7 - 0 0 4 0 B



BACI CUADRA
By Groël Studio
Latón

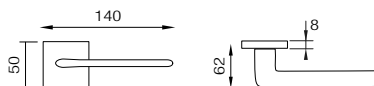

1

Garantía



Serreta



Borjas



Mult.+Desb.



Cromo Mate	5	P 41.5808.4	41.4505.3	41.4503.1	41.5779.3
Cromo Brillo	5	P 41.6809.8	41.4504.2	41.4502.0	41.5780.4
Blanco Mate	5	P 41.6812.0	41.5952.1	41.5953.2	41.5938.1
Negro Mate	10	P 41.6810.9	41.5954.3	41.5955.4	41.5939.2
PVD Grafito	20	P 41.6813.1			
PVD Latón Mate	20	P 41.6808.7			
PVD Pulido Brillo	20	P 41.6807.6			



Uso intenso: Alta frecuencia de uso y probabilidad de uso indebido. Edificios públicos e institucionales; bibliotecas, hospitales y escuelas. **Durabilidad:** 200.000 ciclos. | **Resistencia al fuego:** No. | **Resistencia a la corrosión:** Muy alta (240 h).

EN1906 3 7 - 0 0 4 0 B



NINA



SPECIAL



NINA
By Groël Studio
Latón



SPECIAL
By Groël Studio
Latón

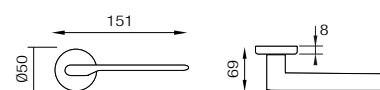







		NINA	SPECIAL	Serreta	Borjas	Mult.+Desb.
📦 1	Garantía					
Cromo Mate	4 10	41.5807.3	P 41.5802.5	41.4500.5	41.4501.6	41.5778.2
Cromo Brillo	4 10		P 41.5801.4	41.4498.3	41.4499.4	41.5777.1
Latón Mate	2 3	41.5806.2		41.4485.4	41.4484.3	41.4483.2



Uso intenso: Alta frecuencia de uso y probabilidad de uso indebido. Edificios públicos e institucionales; bibliotecas, hospitales y escuelas.
Durabilidad: 200.000 ciclos.
Resistencia al fuego: No.
Resistencia a la corrosión: **2** Moderada (48 h) / **4** Muy alta (240 h).



HELICE
By Groël Studio
Latón

	Garantía		Serreta	Borjas	Mult.+Desb.	
 1						
Cromo Mate	4	10	P 41.5784.1	41.4500.5	41.4501.6	41.5778.2
Cromo Brillo	4	10	P 41.5783.0	41.4498.3	41.4499.4	41.5777.1
Pulido Brillo	2	6	P 41.5785.2	41.4497.2	41.4496.1	41.4475.1

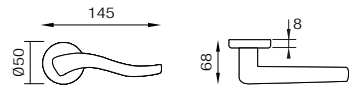

200.000

5 ANOS

10 ANOS

Uso intenso: Alta frecuencia de uso y probabilidad de uso indebido. Edificios públicos e institucionales; bibliotecas, hospitales y escuelas.
Durabilidad: 200.000 ciclos.
Resistencia al fuego: No. | **Resistencia a la corrosión:** **2** Moderada (48 h). / **3** Elevada (96 h). / **4** Muy alta (240 h).



dnd

PLURIS

By Giulio Laccheti
Zamak

Roseta

Serreta

Borjas

Muletilla

1/12

Garantía



Cromo Mate	5	N 41.6917.6	N 41.7017.7	P N 41.7021.0	N 41.7024.3
Negro Mate	5	N 41.6918.7	N 41.7018.8	P N 41.7022.1	N 41.7025.4
Blanco Mate	5	N 41.6919.8	N 41.7019.9	P N 41.7023.2	N 41.7026.5
Oro Mate	5	N 41.7892.2	N 41.7893.3	P N 41.7894.4	N 41.7895.5

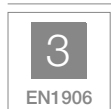

Uso intenso: Alta frecuencia de uso y probabilidad de uso indebido. Edificios públicos e institucionales; bibliotecas, hospitales y escuelas.

Durabilidad: 200.000 ciclos. | **Resistencia al fuego:** No. | **Resistencia a la corrosión:** Muy alta (240 h).

EN1906 3 7 - 0 0 0 0 B



HÁBITAT



Alessandro Stabile
Diseñador Industrial y Director de Arte

dnd

IKI
By Mario Scairato / Alessandro Stabile
Zamak



Mario Scairato
Diseñador Industrial

La maneta IKI tiene una estructura palindrómica, el perfil en la vista superior es idéntico al de la vista frontal, pero invertido 180 grados.

Una forma elegante y esencial en la que los ángulos limpios generan un volumen mutable que concluye con formas semicirculares y sugiere el agarre adecuado con su frontal perfil.

El concepto de equilibrio entre opuestos derivados de la filosofía japonesa ha llevado a los diseñadores a elegir el nombre IKI - otro palindromo - que significa "Simple, sofisticado, espontáneo".

	1	Garantía	Grisans	Serreta	Borjas	Mult.+Desb.
Cromo Mate	5	41.0062.7	P 41.0066.0	41.4500.5	41.4501.6	41.5778.2
Antracita	5	P 41.0063.8	P 41.0067.1	P 41.0310.2	P 41.0311.3	P 41.0309.1
Negro Mate	5	41.0064.9	P 41.0068.2	41.6250.5	41.6251.6	41.6252.0

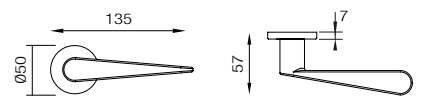

3
EN1906

200.000

GARANTÍA
5
AÑOS

Uso inteno: Alta frecuencia de uso y probabilidad de uso indebido. Edificios públicos e institucionales; bibliotecas, hospitales y escuelas.
Durabilidad: 200.000 ciclos. | **Resistencia al fuego:** No. | **Resistencia a la corrosión:** Elevada (96 h).

EN1906 3 7 - 0 0 0 0 0 B

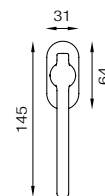

Philippe Tabet
Diseñador Industrial

dnd

SAN
By Philippe Tabet
Zamak

De delicados rasgos, curvas suaves y tangenciales, Philippe Tabet se inspiró en el elegante y esbelto perfil de una katana japonesa para desarrollar este modelo.

Su original empuñadura es a su vez agradable al tacto y cumple a la perfección una honra a la cultura a la que rinde homenaje.



1

Garantía



Grisans



Serreta



Borjas



Mult.+Desb.



Cromo Mate
Antracita
Negro Mate

5
5
5

41.0294.8
41.0295.9
41.0297.0

P 41.0298.1
P 41.0299.2
P 41.0300.3

41.4500.5
P 41.0310.2
41.6250.5

41.4501.6
P 41.0311.3
41.6251.6

41.5778.2
P 41.0309.1
41.6252.0

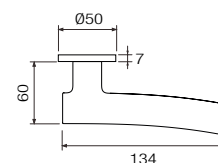

Uso inteso: Alta frecuencia de uso y probabilidad de uso indebido. Edificios públicos e institucionales; bibliotecas, hospitales y escuelas.

Durabilidad: 200.000 ciclos. | **Resistencia al fuego:** No. | **Resistencia a la corrosión:** Elevada (96 h).

EN1906 3 7 - 0 0 0 0 B

SELEC®

Luxury Lever Handle

Una forma elegante y esencial en la que los ángulos rectos crean el recuerdo de los principios del diseño generando una maneta atemporal y perdurable. De agradable y sedoso tacto gracias a sus acabados en Mate.



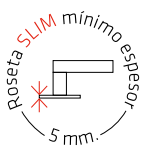

SOHO SLIM

By Selec
Zamak

	Garantía	Serreta	Borjas	Mult.+Desb.
1				
Efecto Inox Mate	5 41.0000.0	41.0008.8	41.0011.0	41.0013.2
Negro Mate	5 41.0001.1	41.0009.9	41.0012.1	41.0014.3

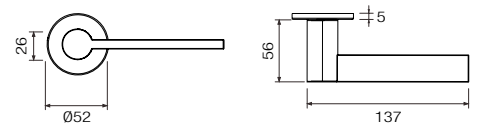

Uso intenso: Alta frecuencia de uso y probabilidad de uso indebido. Edificios públicos e institucionales, bibliotecas, hospitales y escuelas.
Durabilidad: 150.000 ciclos.
Resistencia al fuego: No.
Resistencia a la corrosión: Elevada (120 h).



MILOS

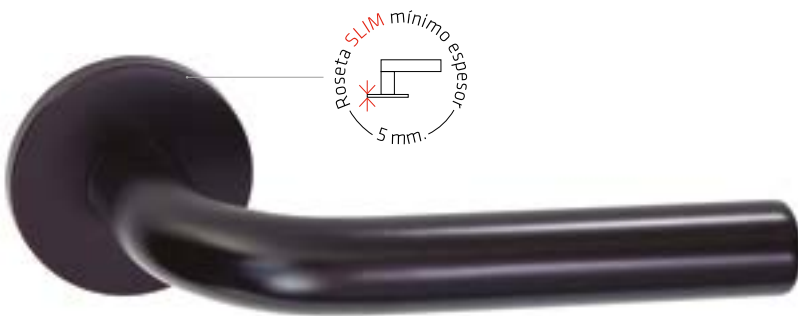
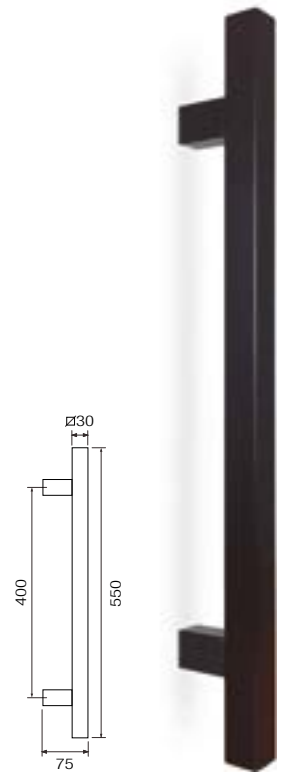

CRETA



SELEC®
Luxury Lever Handle

MILOS SLIM
By Selec
Acero Inoxidable

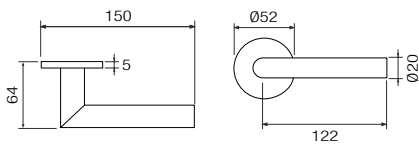

CRETA SLIM
By Selec
Acero Inoxidable

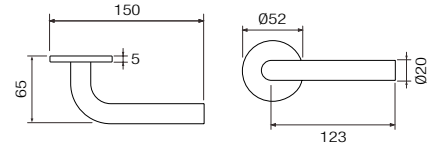

	MILOS	CRETA	Manillón	Manillón Doble	Serreta Ø52	Borjas Ø52	Mult.+Desb. Ø52
1/8 Garantía							
Negro Mate 5	41.0022.0	41.0020.9	41.0035.2	41.0034.1	41.0024.2	41.0023.1	41.0025.3
Blanco Mate 5	N 41.6776.8		N 41.6785.6	N 41.6786.7	N 41.6787.8	N 41.6788.9	N 41.6790.0



Uso medio: Lugares con alguna probabilidad de accidentes o uso indebido. Situaciones internas, oficinas y áreas donde hay acceso limitado al público general.
Durabilidad: 200.000 ciclos. | **Resistencia al fuego:** No. | **Resistencia a la corrosión:** Elevada (96 h).

SELEC[®]
Luxury Lever Handle



El modelo Angle de SELEC permite, gracias a su diseño, soluciones de señalética y/o método braille como instalaciones de interiorismo habitual.

Posibles aplicaciones para hoteles, oficinas y espacios públicos de interés general.

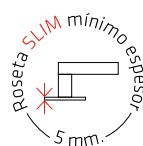

ANGLE SLIM

By Selec
Zamak



1

Garantía



Serreta



Borjas



Mult.+Desb.



Efecto Inox Mate 5
Negro Mate 5

41.0004.4

41.0008.8

41.0011.0

41.0013.2

41.0005.5

41.0009.9

41.0012.1

41.0014.3

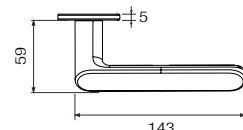
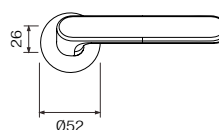

Uso inteso: Alta frecuencia de uso y probabilidad de uso indebido. Edificios públicos e institucionales, bibliotecas, hospitales y escuelas.
Durabilidad: 150.000 ciclos.
Resistencia al fuego: No.
Resistencia a la corrosión: Elevada (120 h).

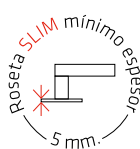

SELEC
Luxury Lever Handle

RINO SLIM
By Selec
Zamak

Efecto Inox Mate	5	41.0002.2	41.0008.8	41.0011.0	41.0013.2

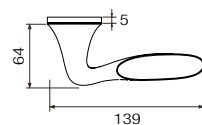
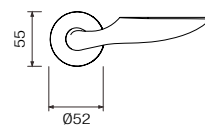

Uso intenso: Alta frecuencia de uso y probabilidad de uso indebido. Edificios públicos e institucionales, bibliotecas, hospitales y escuelas.
Durabilidad: 150.000 ciclos.
Resistencia al fuego: No.
Resistencia a la corrosión: Elevada (120 h).



SELEC
Luxury Lever Handle

FLY SLIM
By Selec
Zamak

1	Garantía	Serreta	Borjas	Mult.+Desb.
Efecto Inox Mate	6	41.0003.3	41.0008.8	41.0011.0
		41.0013.2		

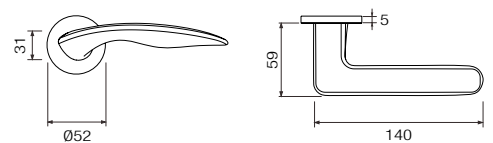

Uso intenso: Alta frecuencia de uso y probabilidad de uso indebido. Edificios públicos e institucionales, bibliotecas, hospitales y escuelas.
Durabilidad: 150.000 ciclos.
Resistencia al fuego: No.
Resistencia a la corrosión: Elevada (120 h).

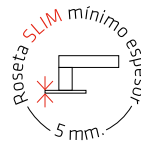

SELEC
Luxury Lever Handle

ELEGANT SLIM

By Selec
Zamak



Efecto Inox Mate/Antracita **5**

Garantía



41.0006.6

Serreta



41.0008.8

Borjas



41.0011.0

Mult.+Desb.



41.0013.2

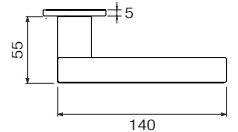
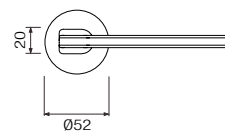

Uso intenso: Alta frecuencia de uso y probabilidad de uso indebido. Edificios públicos e institucionales, bibliotecas, hospitales y escuelas.
Durabilidad: 150.000 ciclos.
Resistencia al fuego: No.
Resistencia a la corrosión: Elevada (120 h).



SELEC[®]
Luxury Lever Handle

FINGER SLIM
By Selec
Zamak



Efecto Inox Mate

Garantía

5



41.0007.7

Serreta



41.0008.8

Borjas



41.0011.0

Mult.+Desb.



41.0013.2

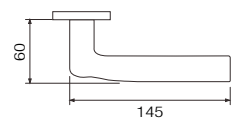
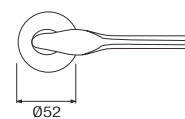

Uso intenso: Alta frecuencia de uso y probabilidad de uso indebido. Edificios públicos e institucionales, bibliotecas, hospitales y escuelas.
Durabilidad: 150.000 ciclos.
Resistencia al fuego: No.
Resistencia a la corrosión: Elevada (120 h).



SELEC®
Luxury Lever Handle

NICOLE
By Selec
Zamac/Cuero

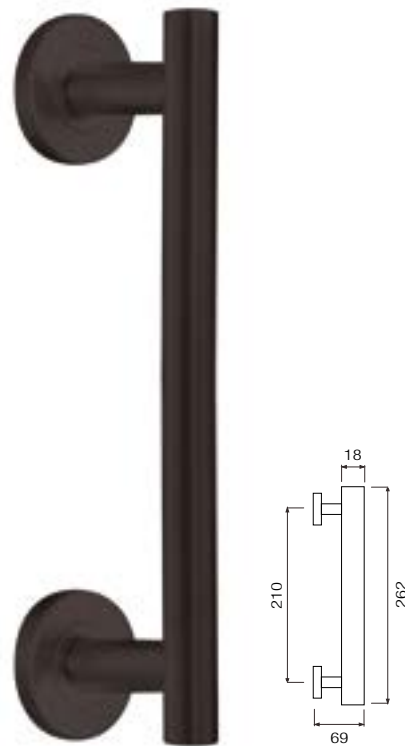
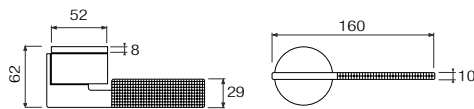

1	Garantía	Roseta	Manillón	Serreta	Borjas	Muletilla
Negro Mate/Cuero Negro	3	N 41.6964.9	N 41.6977.0	41.6599.4	N 41.6982.5	N 41.6971.5



Uso intenso: Alta frecuencia de uso y probabilidad de uso indebido. Edificios públicos e institucionales, bibliotecas, hospitales y escuelas.
Durabilidad: 150.000 ciclos.
Resistencia al fuego: No.
Resistencia a la corrosión: Muy alta (240 h).

SELEC®
Luxury Lever Handle

INGRID
By Selec
Acero Inox AISI 304

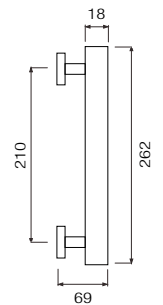

	Roseta	Manillón	Serreta	Borjas	Muletilla
1					
Efecto Inox	5 N 41.6967.1	N 41.6975.9	41.2989.6	41.2990.0	N 41.6969.3
Negro Mate	5 N 41.6968.2	N 41.6977.0	N 41.6980.3	N 41.6982.5	N 41.6971.5

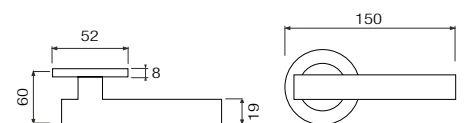









Uso intenso: Alta frecuencia de uso y probabilidad de uso indebido. Edificios públicos e institucionales, bibliotecas, hospitales y escuelas.
Durabilidad: 150.000 ciclos.
Resistencia al fuego: No.
Resistencia a la corrosión: Muy alta (240 h).



SELEC®
Luxury Lever Handle

MARIAM
By Selec
Zamac

	Roseta	Manillón	Serreta	Borjas	Muletilla
 1					
Garantía					
Negro Mate	3  41.6966.0	41.6705.5	41.6599.4	 41.6982.5	 41.6971.5





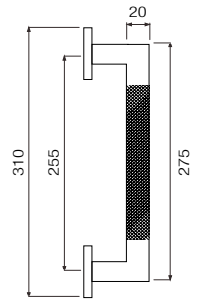



Uso medio: Lugares con alguna probabilidad de accidentes o uso indebido. Situaciones internas, oficinas y áreas donde hay acceso limitado al público general.
Durabilidad: 150.000 ciclos. ! **Resistencia al fuego:** No. ! **Resistencia a la corrosión:** Muy alta (240 h).



SELEC[®]
Luxury Lever Handle

ITACA
By Selec
Acero Inox AISI 304

	Roseta	Manillón	Serreta	Borjas	Muletilla
 1					
Efecto Inox	5 N 41.6961.6	N 41.6972.6	41.2989.6	41.2990.0	N 41.6969.3
Negro Mate	5 N 41.6963.8	N 41.6974.8	N 41.6980.3	N 41.6982.5	N 41.6971.5
PVD Oro Mate	5 N 41.6962.7	N 41.6973.7	N 41.6979.2	N 41.6981.4	N 41.6970.4



Uso inteso: Alta frecuencia de uso y probabilidad de uso indebido. Edificios públicos e institucionales, bibliotecas, hospitales y escuelas.
Durabilidad: 150.000 ciclos.
Resistencia al fuego: No.
Resistencia a la corrosión: Muy alta (240 h).





SELEC[®]
Luxury Lever Handle

HERA GOLD
By Selec D&D
Acero Inox AISI 304



PVD Oro Mate

Garantía

10



41.6728.0

Manillón



41.6731.3

Serreta
Ø54 mm.



41.6729.1

Mult.+Desb.
Ø54 mm.



41.6730.2

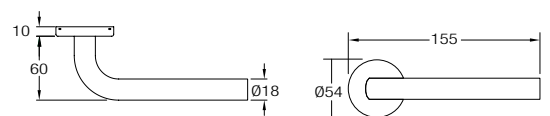

Uso medio: Lugares con alguna probabilidad de accidentes o uso indebido. Situaciones internas, oficinas y áreas donde hay acceso limitado al público general.

Durabilidad: 200.000 ciclos.

Resistencia al fuego: No.

Resistencia a la corrosión: Extremadamente Alta (1.500 h).

dnd

LUCE-02

By DND Technical Division
Zamak

1/30

Garantía



Serreta



Borjas



Mult.+Desb.



Cromo Mate

5

41.5769.0

41.4505.3

41.4503.1

41.5779.3

Cromo Brillo

5

41.5771.2

41.4504.2

41.4502.0

41.5780.4

Negro Mate

5

N 41.6912.1

41.5954.3

41.5955.4

41.5939.2

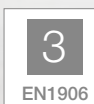
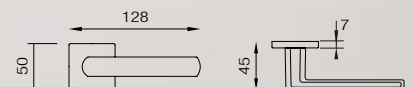
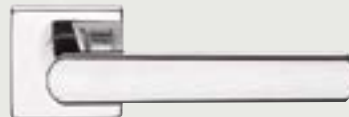

Uso intenso: Alta frecuencia de uso y probabilidad de uso indebido. Edificios públicos e institucionales; bibliotecas, hospitales y escuelas.

Durabilidad: 200.000 ciclos. | **Resistencia al fuego:** No. | **Resistencia a la corrosión:** Muy alta (240 h).

EN1906 3 7 - 0 0 0 0 B

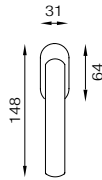

dnd

LUCE

By DND Technical Division
Zamak

1/30

Garantía



Grisans



Serreta



Borjas



Mult.+Desb.



Cromo Mate
Cromo Brillo
Negro Mate
Cuero Latón Patinado
Latón Mate

4	5	41.5768.6	41.5863.3	41.4500.5	41.4501.6	41.5778.2
4	5	41.5770.1	41.5864.4	41.4498.3	41.4499.4	41.5777.1
4	5	41.6249.4	41.6450.2	41.6250.5	41.6251.6	41.6252.0
2	2	41.5772.3	41.5866.6	41.4757.3	41.7026.5	N 41.7910.9
2	3	N 41.6857.1		41.4485.4	41.4484.3	41.4483.2

41.5863.3
41.5864.4
41.6450.2
41.5866.6

41.4500.5
41.4498.3
41.6250.5
41.4757.3
41.4485.4

41.4501.6
41.4499.4
41.6251.6
41.7026.5
41.4484.3

41.5778.2
41.5777.1
41.6252.0
N 41.7910.9
41.4483.2



3
EN1906

200.000

GARANTÍA 2 AÑOS
GARANTÍA 3 AÑOS
GARANTÍA 5 AÑOS

Uso intenso: Alta frecuencia de uso y probabilidad de uso indebido. Edificios públicos e institucionales; bibliotecas, hospitales y escuelas. | **Durabilidad:** 200.000 ciclos. | **Resistencia al fuego:** No.
Resistencia a la corrosión: 2 Moderada (48 h). / 4 Muy alta (240 h).

EN1906 3 7 - 0 0 0 0 B



Espesor 4 mm
muelle zamak +



dnd

LUCE FINE

By DND Technical Division
Zamak

1/30	Garantía			Serreta	Borjas	Mult.+Desb.	Serreta	Borjas	Mult.+Desb.
Cromo Mate	5	41.6248.3	41.6247.2	41.5946.2	41.5947.3	41.5935.5	41.6001.1	41.6002.2	41.5999.6

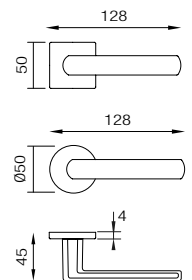

3
EN1906

200.000

GARANTÍA
5
AÑOS

Uso intenso: Alta frecuencia de uso y probabilidad de uso indebido. Edificios públicos e institucionales; bibliotecas, hospitales y escuelas. | **Durabilidad:** 200.000 ciclos. | **Resistencia al fuego:** No.
Resistencia a la corrosión: Muy alta (240 h).

EN1906 **3 7 - 0 0 0 0 B** Certificado con sistema de roseta VIS (7 mm). **P** Solo bajo pedido.



dnd

LUCE P

By DND Technical Division
Zamak

1/20 Garantía 						Serreta	Borjas	Mult.+Desb.
						Latón Mate N 41.6913.2 Cuero Latón N 41.6914.3	41.4485.4 41.4757.3	41.4484.3 N 41.7027.6

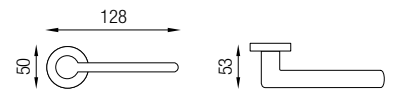

3
EN1906

200.000

GARANTÍA
2
AÑOS

Uso intenso: Alta frecuencia de uso y probabilidad de uso indebido. Edificios públicos e institucionales; bibliotecas, hospitales y escuelas. | **Durabilidad:** 200.000 ciclos. | **Resistencia al fuego:** No.
Resistencia a la corrosión: Moderada (48 h).

EN1906 **3 7 - 0 0 0 0 B**



CHOP



QUATTRO-Z

dnd

CHOP

By Didier Schweizer
Zamak

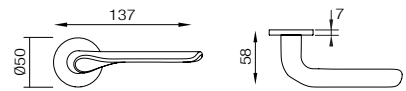

QUATTRO-Z

By DND Tech. Division
Zamak

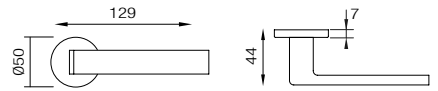

		CHOP	QUATTRO-Z	Serreta	Borjas	Mult.+Desb.
Garantía	1					
Cromo Mate	5	41.6446.5	41.4686.2	41.4500.5	41.4501.6	41.5778.2
Cromo Brillo	5		P 41.4685.1	41.4498.3	41.4499.4	41.5777.1
Negro Mate	5	N 41.6916.5		41.6250.5	41.6251.6	41.6252.0

3
EN1906

200.000

Uso intenso: Alta frecuencia de uso y probabilidad de uso indebido. Edificios públicos e institucionales; bibliotecas, hospitales y escuelas.
Durabilidad: 200.000 ciclos. | **Resistencia al fuego:** No. | **Resistencia a la corrosión:** Muy alta (240 h).

EN1906 3 7 - 0 0 0 0 B



dnd

QUATTRO 02-Z

By DND Technical Division
Zamak

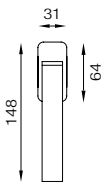

		Grísán	Serreta	Borjas	Mult.+Desb.	
1/30	Garantía					
Cromo Mate	5	41.5867.0	41.5869.2	41.4505.3	41.4503.1	41.5779.3
Cromo Brillo	5	41.5868.1	41.5870.3	41.4504.2	41.4502.0	41.5780.4
Negro Mate	5 N	41.6915.4	41.5954.3	41.5955.4	41.5939.2	

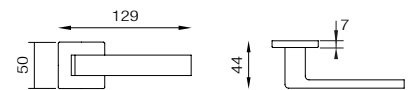

Uso inteno: Alta frecuencia de uso y probabilidad de uso indebido. Edificios públicos e institucionales; bibliotecas, hospitales y escuelas. | **Durabilidad:** 200.000 ciclos. | **Resistencia al fuego:** No.
Resistencia a la corrosión: Muy alta (240 h).

EN1906 3 7 - 0 0 0 0 B

dnd

FOLD

By Mario Padiglione
Zamak



	Garantía	Serreta	Borjas	Mult.+Desb.
1/30				
Cromo Mate	5	41.6448.0	41.4505.3	41.4503.1
Negro Mate	5	41.6449.1	41.5954.3	41.5955.4
				41.5779.3
				41.5939.2

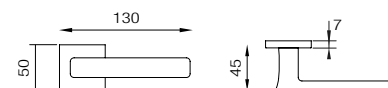

Uso intenso: Alta frecuencia de uso y probabilidad de uso indebido. Edificios públicos e institucionales; bibliotecas, hospitales y escuelas. | **Durabilidad:** 200.000 ciclos. | **Resistencia al fuego:** No.

Resistencia a la corrosión: Muy alta (240 h).

EN1906 3 7 - 0 0 0 0 B



STICK

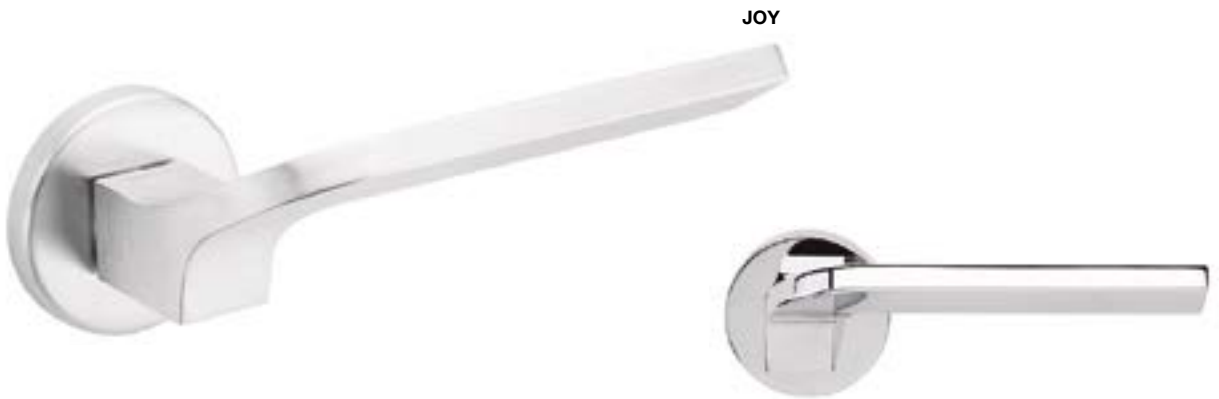

JOY

dnd

STICK

By Novelletto - Greco Zamak

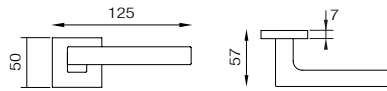

1/30	Garantía	Serreta	Borjas	Mult.+Desb.	
Cromo Mate	5	41.4367.5	41.4505.3	41.4503.1	41.5779.3

JOY

By Nicola Novelletto Zamak

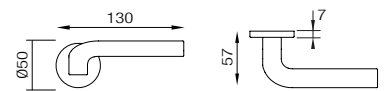

1	Garantía	Serreta	Borjas	Mult.+Desb.	
Cromo Mate	5	P 41.4788.6	41.4500.5	41.4501.6	41.5778.2
Cromo Brillo	5	P 41.4789.0	41.4498.3	41.4499.4	41.5777.1

3
EN1906

200.000

GARANTÍA 5 AÑOS



Uso intenso: Alta frecuencia de uso y probabilidad de uso indebido. Edificios públicos e institucionales; bibliotecas, hospitales y escuelas. | **Durabilidad:** 200.000 ciclos. | **Resistencia al fuego:** No.
Resistencia a la corrosión: Muy alta (240 h).

EN1906 3 7 - 0 0 0 0 B



SELEC[®]
Luxury Lever Handle

IONE PLUS
By Selec D&D
Acero Inoxidable

 1	Garantía		Maneta		Serreta		Borjas		Mult.+Desb.
Inox Mate	5	41.4087.5	41.4682.5	41.2989.6	41.2990.0	41.3124.1			

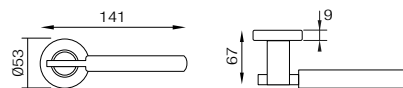

Uso intenso: Alta frecuencia de uso y probabilidad de uso indebido. Edificios públicos e institucionales; bibliotecas, hospitales y escuelas.
Durabilidad: 200.000 ciclos.
Resistencia al fuego: No.
Resistencia a la corrosión: Muy alta (240 h).

SELEC®
Luxury Lever Handle

LEILA SLIM
By Selec D&D
Zamak



1	Garantía	Serreta	Borjas	Mult.+Desb.	
Cromo Mate	3 5	N 41.6757.0	N 41.6760.3	N 41.6791.1	N 41.6792.2
Negro Mate	2 5	41.6758.1	41.0024.2	41.0023.1	41.0025.3
Blanco Mate	2 5	N 41.6759.2	N 41.6787.8	N 41.6788.9	N 41.6790.0

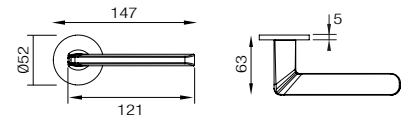

2
EN1906

3
EN1906

200.000

GARANTÍA
5
AÑOS

Uso medio: 2 Lugares con alguna probabilidad de accidentes o uso indebido. Situaciones internas, oficinas y áreas donde hay acceso limitado al público general. **Uso intenso:** 3 Alta frecuencia de uso y probabilidad de uso indebido. Edificios públicos e institucionales; bibliotecas, hospitales y escuelas.

Durabilidad: 200.000 ciclos. | **Resistencia al fuego:** No. | **Resistencia a la corrosión:** Muy alta (240 h).

EN1906 7 - 0 0 4 0 B ■ Especifica por acabado



groël
handle design

SOFT
By Groël Studio
Latón

1	Garantía	Serreta	Borjas	Mult.+Desb.	
Cromo Brillo/Mate	4 10	41.5805.1	41.4500.5	41.4501.6	41.5778.2
Latón Brillo/Mate	2 10	41.5804.0	41.4485.4	41.4484.3	41.4483.2

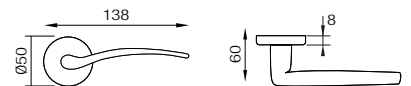

200.000

GARANTÍA
10
AÑOS

Uso medio: Lugares con alguna probabilidad de accidentes o uso indebido. Situaciones internas, oficinas y áreas donde hay acceso limitado al público general. **Durabilidad:** 200.000 ciclos. | **Resistencia al fuego:** No.
Resistencia a la corrosión: 2 Moderada (48 h). / 3 Elevada (96 h)

AURORA



SELENA

endex
by groël

AURORA
By Groël Studio
Zamak

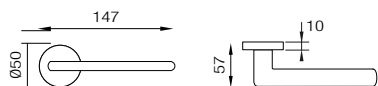

SELENA
By Groël Studio
Zamak

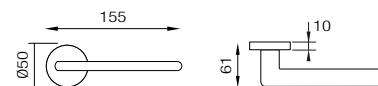

		AURORA	SELENA	Serreta	Borjas	Mult.+Desb.
1/30	Garantía					
Cromo Mate	5	41.6504.0	41.6503.6	41.4500.5	41.4501.6	41.5778.2
Negro Mate	5	41.6505.1		41.6250.5	41.6251.6	41.6252.0



Uso medio: Lugares con alguna probabilidad de accidentes o uso indebido. Situaciones internas, oficinas y áreas donde hay acceso limitado al público general.
Durabilidad: 200.000 ciclos.
Resistencia al fuego: No.
Resistencia a la corrosión: Elevada (96 h).

ALICIA

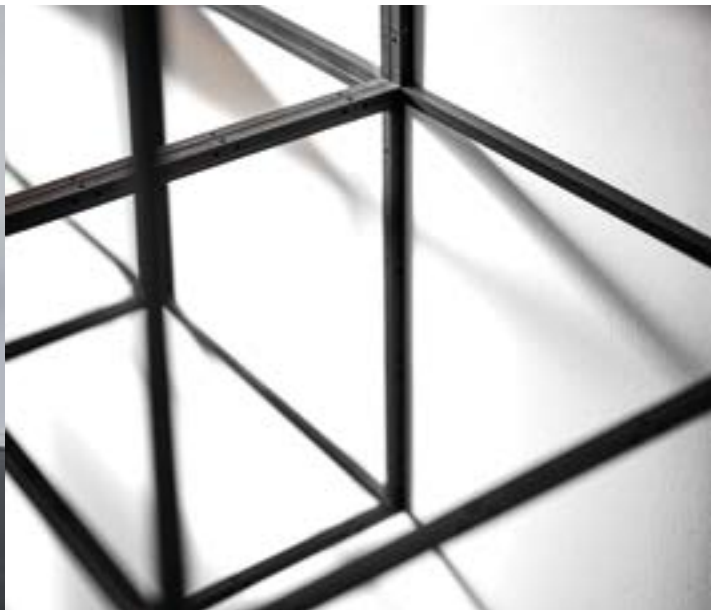
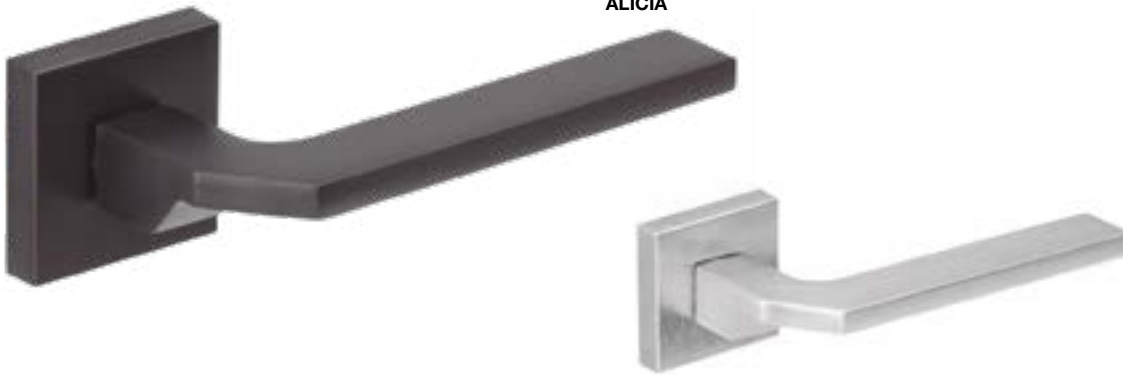

ELSA

endex
by groël

ALICIA
By Groël Studio
Zamak

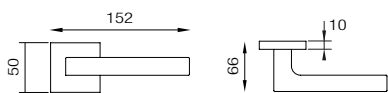

	Serreta	Borjas	Mult.+Desb.
1/30			
Garantía			
Cromo Mate	5	41.7917.5	41.6596.1
Negro Mate	5	41.6502.5	41.5955.4
		41.4503.1	41.6600.5
		41.5955.4	41.6601.6

ELSA
By Groël Studio
Zamak

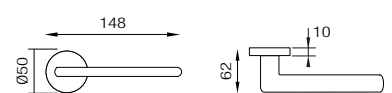

	Serreta	Borjas	Mult.+Desb.
1			
Garantía			
Cromo Mate	5	41.5811.0	41.4500.5
		41.4501.6	41.6602.0



Uso medio: Lugares con alguna probabilidad de accidentes o uso indebido. Situaciones internas, oficinas y áreas donde hay acceso limitado al público general.
Durabilidad: 200.000 ciclos.
Resistencia al fuego: No.
Resistencia a la corrosión: Elevada (96 h).



CHRONOS



BALLY

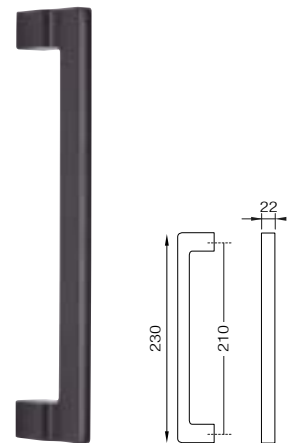

endex
by groël

CHRONOS
By Groël Studio
Zamak

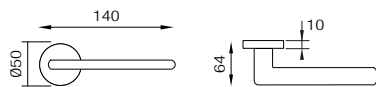

BALLY
By Groël Studio
Zamak

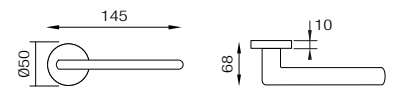

		CHRONOS	BALLY	Manillón	Serreta Ø50 mm.	Borjas Ø50 mm.	Mult.+Desb. Ø50 mm.
📦 1	Garantía						
Cromo Mate	5	41.6699.6	41.6702.2	41.6704.4	41.4500.5	41.4501.6	41.6602.0
Negro Mate	5	41.6700.0	41.6703.3	41.6705.5	41.6599.4	41.6251.6	41.6603.1
Blanco Mate	5	41.6701.1		41.6706.6	41.6708.1	41.6709.2	41.6707.0



Uso medio: Lugares con alguna probabilidad de accidentes o uso indebido. Situaciones internas, oficinas y áreas donde hay acceso limitado al público general.
Durabilidad: 200.000 ciclos.
Resistencia al fuego: No.
Resistencia a la corrosión: Elevada (96 h).

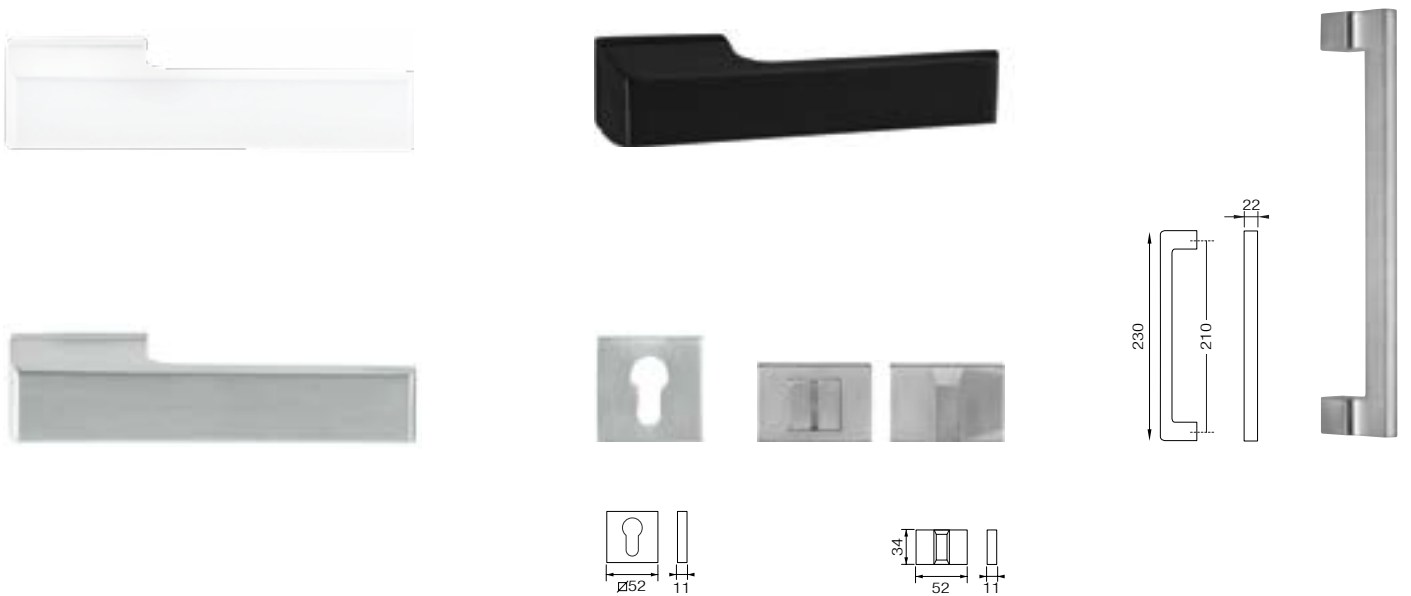

TOTAL

Zamak

	Manillón	Serreta	Mult.+Desb.
1/8 Garantía 			
Cromo Mate 2 5 41.6710.3	41.6704.4	41.6716.2	41.6713.6
Negro Mate 3 5 41.6711.4	41.6705.5	41.6717.3	41.6714.0
Blanco Mate 3 5 41.6712.5	41.6706.6	41.6718.4	41.6715.1

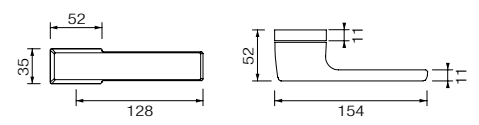

Uso medio: Lugares con alguna probabilidad de accidentes o uso indebido. Situaciones internas, oficinas y áreas donde hay acceso limitado al público general. **Durabilidad:** 200.000 ciclos. | **Resistencia al fuego:** No.
Resistencia a la corrosión: **2** Moderada (48 h). / **3** Elevada (96 h).

EN1906 **2** **7** - **2** **0** **0** **B** **■** Especifica por acabado

SELEC®
Luxury Lever Handle

ZEUS PLUS
By Selec D&D
Acero Inoxidable

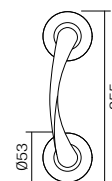
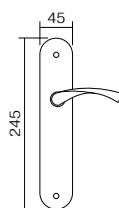

 1	Garantía		Maneta		Manillón		Serreta		Borjas		Mult.+Desb.
Inox Mate	5	41.3172.0	41.4646.4	41.4089.0	41.2989.6	41.2990.0	41.3124.1				

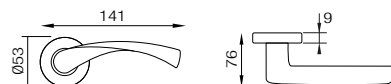

Uso intenso: Alta frecuencia de uso y probabilidad de uso indebido. Edificios públicos e institucionales; bibliotecas, hospitales y escuelas.
Durabilidad: 200.000 ciclos.
Resistencia al fuego: No.
Resistencia a la corrosión: Muy alta (240 h).

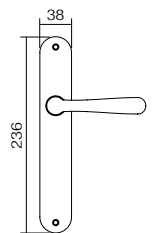
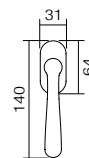

dnd

HANDY
By Mauro Ronchi
Latón

	Garantía	Maneta	Grisán	Serreta	Borjas	Mult.+Desb.	
1							
Cromo Mate	4 10	41.4487.6	41.3372.4	41.4706.1	41.4500.5	41.4501.6	41.5778.2
Cromo Brillo	4 10	41.4489.1	41.3404.1		41.4498.3	41.4499.4	41.5777.1
Latón Mate	2 3	41.4488.0	41.3403.0		41.4485.4	41.4484.3	41.4483.2
Pulido Brillo	2 3	41.4486.5	41.3371.3	41.4707.2	41.4497.2	41.4496.1	41.4475.1



Uso intenso: Alta frecuencia de uso y probabilidad de uso indebido. Edificios públicos e institucionales; bibliotecas, hospitales y escuelas. | **Durabilidad:** 200.000 ciclos. | **Resistencia al fuego:** No.
Resistencia a la corrosión: 2 Moderada (48 h). / 4 Muy alta (240 h).

EN1906 3 7 - 0 0 0 0 B



dnd

AIRONE
By Mauro Ronchi
Latón

	Garantía	Serreta	Borjas	Mult.+Desb.	
1					
Pulido Brillo	2 3	41.5924.1	41.4497.2	41.4496.1	41.4475.1
Latón Mate	2 3	41.5925.2	41.4485.4	41.4484.3	41.4483.2
Cromo Brillo	4 10	41.5926.3	41.4498.3	41.4499.4	41.5777.1

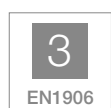
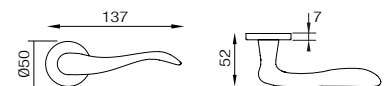

Uso intenso: Alta frecuencia de uso y uso indebido. Edificios públicos e institucionales; bibliotecas, hospitales y escuelas. | **Durabilidad:** 200.000 ciclos. | **Resistencia al fuego:** 2 Si: **AIRONE** / 0 No: **WING**
Resistencia a la corrosión: 2 Moderada (48 h.) / 4 Muy alta (240 h.)

EN1906 3 7 - 0 0 0 B ■ Especifico por modelo.



SANTORINI



Especialmente diseñadas para **tapar el pomo americano** aportando un nuevo estilo a las puertas.



ALICANTE



ALICANTE
Roseta Ø65
Zamak

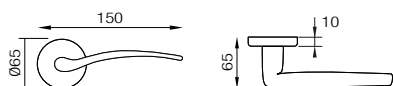

SANTORINI
Roseta Ø65
Zamak

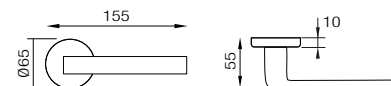

		ALICANTE	SANTORINI	Serreta*	Borjas*	Mult.+Desb.*
1	Garantía					
	Pulido Brillo	2 41.6494.4		41.4497.2	41.4496.1	41.4475.1
	Efecto Inox	2 41.6495.5		41.4649.0		41.3800.5
	Cromo Mate	2	N 41.0103.4	41.4500.5	41.4501.6	41.5778.2
	Negro Mate	2	N 41.0102.3	41.6599.4	41.6251.6	41.6603.1

* Atención: Los complementos son de Ø50 mm.



Uso muy ligero: Manillas de bajo coste para puertas interiores de uso exclusivo en viviendas. Frecuencia baja de uso por personas cuidadosas y con poco riesgo de mala utilización.

Durabilidad: 100.000 ciclos.

Resistencia al fuego: No.

Resistencia a la corrosión: Baja (24 h).



BOHO
Hierro Industrial

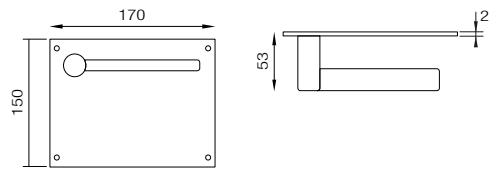
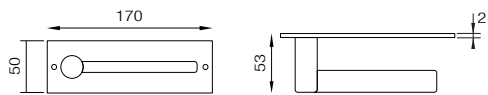
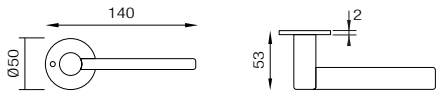

	Jgo. Rosetas	Jgo. Manetas con Placa	Jgo. Manetas con Placa	Jgo. Rosetas forma de "T"	Grisans	Manillón	Manillón con placa	Bocallave Serreta
1	42.1110.4	42.1111.5	42.1112.6*	42.1113.0	42.1126.6	42.1121.1	42.1122.2	42.1117.4



Uso inteso: Alta frecuencia de uso y probabilidad de uso indebido. Edificios públicos e institucionales; bibliotecas, hospitales y escuelas.
Durabilidad: 200.000 ciclos.
Resistencia al fuego: No.
Resistencia a la corrosión: Elevada (96 h).

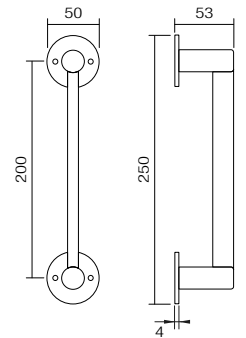
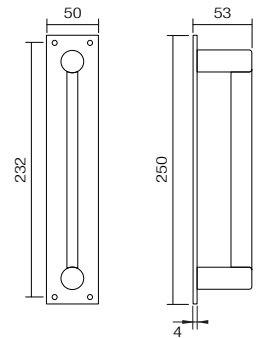

Con muelle.

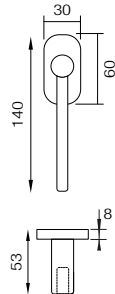
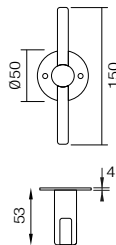

Bocallave Serreta

42.1118.5

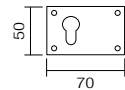

Mult. + Desb. Roseta

42.1114.1

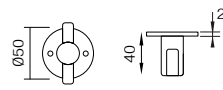

Mult. + Desb. con placa

42.1115.2

Mult. + Desb.



42.1116.3

Tope puerta



41.6994.6

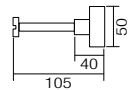
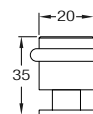
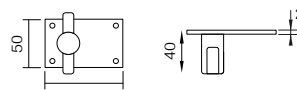

Muletilla y desbloqueo para instalar en placa



Uso inteso: Alta frecuencia de uso y probabilidad de uso indebido. Edificios públicos e institucionales; bibliotecas, hospitales y escuelas.
Durabilidad: 200.000 ciclos.
Resistencia al fuego: No.
Resistencia a la corrosión: Elevada (96 h).

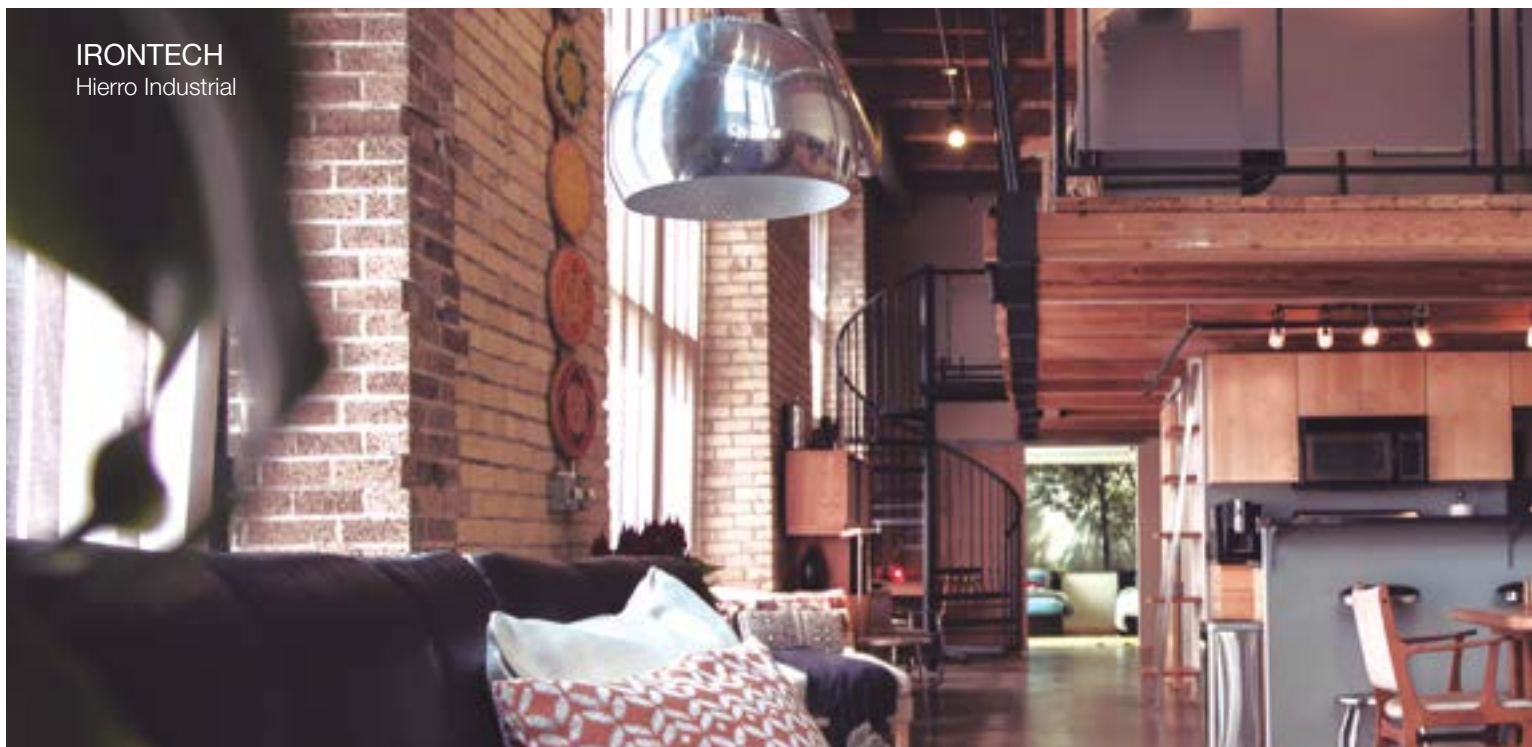

IRONTECH
Hierro Industrial

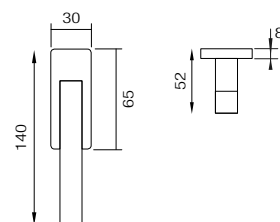
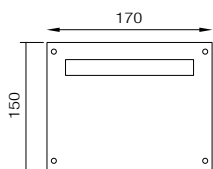
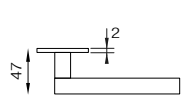
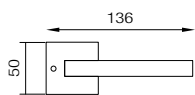

	Jgo. Rosetas	Jgo. Manetas con Placa	Grisans	Manillón	Borjas	Mult.+Desb.	Kit 2 tiradores con Mult. + Desb. + Dedal redondo	Kit 2 tiradores + dedal redondo
Negro Industrial	42.1127.0	42.1128.1	42.1132.5	42.1129.2	42.1131.4	42.1130.3	42.1120.0	42.1119.6



Uso intenso: Alta frecuencia de uso y probabilidad de uso indebido. Edificios públicos e institucionales; bibliotecas, hospitales y escuelas.
Durabilidad: 200.000 ciclos.
Resistencia al fuego: No.
Resistencia a la corrosión: Elevada (96 h).



BOHO · IRONTECH

Hierro Industrial

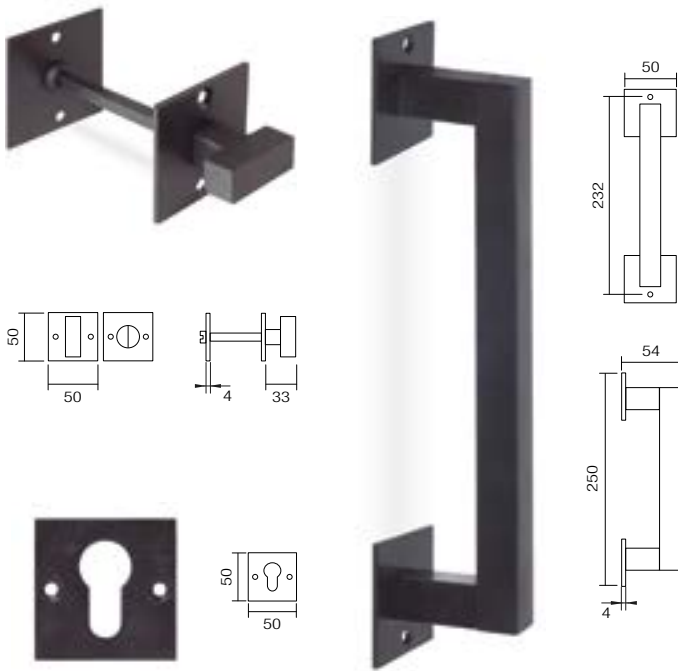
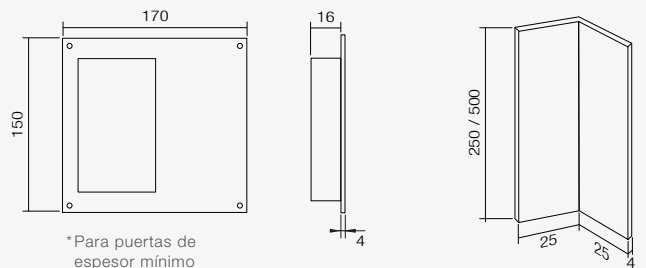

Asa corredera
250 mm.

Asa corredera
500 mm.

Tope puerta



42.1123.3

42.1124.4

N 41.6995.7



Uso intenso: Alta frecuencia de uso y probabilidad de uso indebido. Edificios públicos e institucionales; bibliotecas, hospitales y escuelas.
Durabilidad: 200.000 ciclos.
Resistencia al fuego: No.
Resistencia a la corrosión: Elevada (96 h).

ESTILLOS SOTILS



dnd



Marco Pisati
Diseñador y Arquitecto

Moderno Renacimiento.

Referencias renacentistas en la forma fina del tallo, unidas por el diseño de la empuñadura: una forma rectangular iluminada por cenefas de formas elegantes.



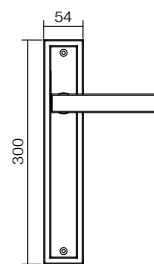
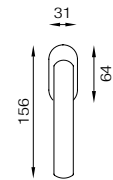
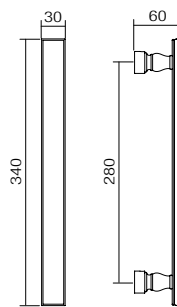
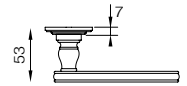
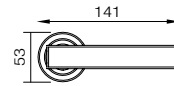

LUCREZIA

By Marco Pisati

Latón



Garantía

Roseta



Maneta placa



Manillon



Grisans



Serreta
Ø53 mm.



Borja
Ø53 mm.



Mult. + Desb.
Ø53 mm.



Cuero Latón Patinado **3** **2** **P** 41.6436.2
 PVD Oro Antiguo Brillo **3** **5** **P** 41.6434.0
 PVD Níquel Brillo **4** **10** **P** 41.6435.1

P 41.6439.5
P 41.6437.3
P 41.6438.4

P 41.6445.4
P 41.6443.2
P 41.6444.3

P 41.6442.1
P 41.6440.6
P 41.6441.0

P 41.6424.4
P 41.6426.6
P 41.6425.5

P 41.6429.2
P 41.6431.4
P 41.6430.3

P 41.6416.3
P 41.6418.5
P 41.6417.4

P 41.6416.3
P 41.6418.5
P 41.6417.4

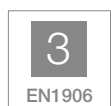

Uso intenso: Alta frecuencia de uso y probabilidad de uso indebido. Edificios públicos e institucionales; bibliotecas, hospitales y escuelas. | **Durabilidad:** 200.000 ciclos.
Resistencia al fuego: Si. | **Resistencia a la corrosión:** **3** Elevada (96 h). / **4** Muy alta (240 h).

EN1906 **3** **7** - **2** **0** **0** **0** **B**

dnd



Marco Pisati
Diseñador y Arquitecto

Moderno Clasicismo.
Un cilindro y molduras ligeras, entre formas clásicas y volúmenes modernos.



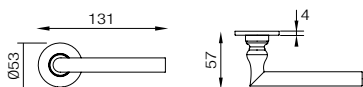

ISABELLA

By Marco Pisati
Latón



Garantía

Roseta

Grisans

Serreta
Ø53 mm.

Borjas
Ø53 mm.

Mult. + Desb.
Ø53 mm.



Cuero Latón Patinado **3** **2**
 PVD Oro Antiguo Brillo **4** **10**
 PVD Oro Antiguo Satinado **4** **10**
 PVD Níquel Brillo **4** **10**

P 41.6404.5
P 41.6406.0
P 41.6407.1
P 41.6405.6

P 41.6412.6
P 41.6414.1
P 41.6415.2
P 41.6413.0

P 41.6424.4
P 41.6426.6
P 41.6427.0
P 41.6425.5

P 41.6429.2
P 41.6431.4
P 41.6432.5
P 41.6430.3

P 41.6419.6
P 41.6422.2
P 41.6423.3
P 41.6420.0

*Plazo de entrega de 8 semanas.







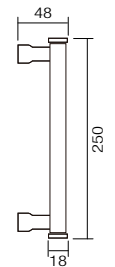
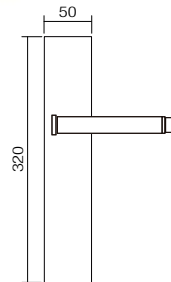
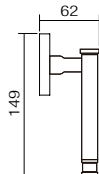
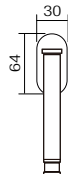
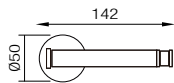
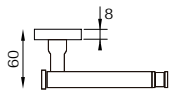



Uso intenso: Alta frecuencia de uso y probabilidad de uso indebido. Edificios públicos e institucionales; bibliotecas, hospitales y escuelas. | **Durabilidad:** 200.000 ciclos. | **Resistencia al fuego:** Si. **Resistencia a la corrosión:** **3** Elevada (96 h). / **4** Muy alta (240 h).

EN1906 **3** **7** - **2** **0** **0** **0** **B**



ATELIER

VASILISA

Latón	Roseta	Maneta placa	Maneta placa + Muletilla*	Manillón	Grisans	Serreta Ø50 mm.	Borja Ø50 mm.	Mult. + Desb. Ø50 mm.
 1								
Níquel Brillo 2	P 41.6349.6	P 41.6351.1	P 41.6353.3	P 41.6357.0	P 41.6355.5	P 41.6361.4	P 41.6359.2	P 41.6363.6
Latón Pulido 2	P 41.6350.0	P 41.6352.2	P 41.6354.4	P 41.6358.1		P 41.6362.5	P 41.6360.3	P 41.6364.0

*En el caso de necesitar muletilla, indicar en el pedido la distancia del centro del cuadrado al centro de la muletilla para su mecanización.



Uso intenso: Alta frecuencia de uso y probabilidad de uso indebido. Edificios públicos e institucionales; bibliotecas, hospitales y escuelas.
Durabilidad: 200.000 ciclos.
Resistencia al fuego: No.
Resistencia a la corrosión: Moderada (48 h).

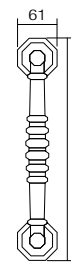
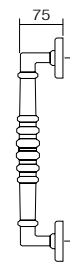
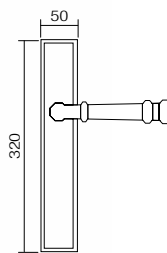
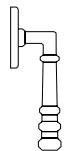
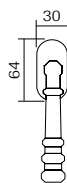
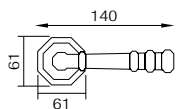
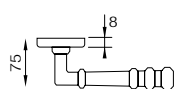

ATELIER

OTTO

Latón	Roseta	Maneta placa	Maneta placa + Muletilla*	Manillón	Grisans	Serreta 61x61 mm.	Borja 61x61 mm.	Mult. + Desb. 61x61 mm.		
1										
Latón Pulido	2	2	P 41.6365.1	P 41.6368.4	P 41.6371.0	P 41.6377.6	P 41.6374.3	P 41.6383.5	P 41.6380.2	P 41.6386.1
Cromo Brillo	4	10	P 41.6366.2	P 41.6369.5	P 41.6372.1	P 41.6378.0	P 41.6375.4	P 41.6384.6	P 41.6381.3	P 41.6387.2
Bronce Inglés	2	2	P 41.6367.3	P 41.6370.6	P 41.6373.2	P 41.6379.1	P 41.6376.5	P 41.6385.0	P 41.6382.4	P 41.6388.3

*En el caso de necesitar muletilla, indicar en el pedido la distancia del centro del cuadrado al centro de la muletilla para su mecanización.



Uso intenso: Alta frecuencia de uso y probabilidad de uso indebido. Edificios públicos e institucionales; bibliotecas, hospitales y escuelas.
Durabilidad: 200.000 ciclos. | **Resistencia al fuego:** No.
Resistencia a la corrosión: 2 Moderada (48 h.) / 4 Muy alta (240 h).



ATELIER

TROMBETTA

Latón

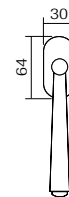
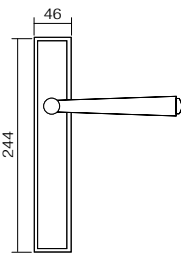

	Roseta	Maneta placa	Maneta placa + Muletilla*	Grisans	Serreta Ø50 mm.	Borja Ø50 mm.	Mult. + Desb. Ø50 mm.
Garantía							
Níquel Brillo	2	P 41.6305.4	P 41.6307.6	P 41.6309.1	P 41.6311.3	P 41.6317.2	P 41.6313.5
Latón Pulido	2	P 41.6306.5	P 41.6308.0	P 41.6310.2	P 41.6312.4	P 41.6318.3	P 41.6321.6
							P 41.6322.0

*En el caso de necesitar muletilla, indicar en el pedido la distancia del centro del cuadrado al centro de la muletilla para su mecanización



Uso inteso: Alta frecuencia de uso y probabilidad de uso indebido. Edificios públicos e institucionales; bibliotecas, hospitales y escuelas.
Durabilidad: 200.000 ciclos.
Resistencia al fuego: No.
Resistencia a la corrosión: Moderada (48 h).

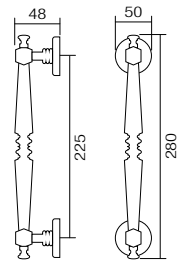







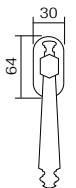
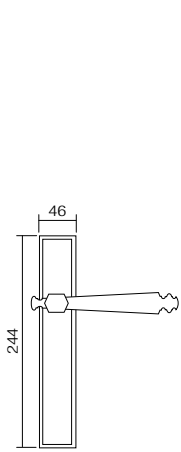
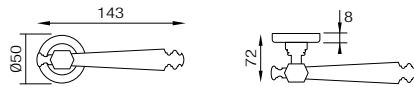



ATELIER

MANEGA

Latón



	Roseta	Maneta placa	Maneta placa + Muletilla*	Manillón	Grisans	Serreta Ø50 mm.	Borja Ø50 mm.	Mult. + Desb. Ø50 mm.
 1								
Níquel Brillo	 2 P 41.6325.3	P 41.6327.5	P 41.6329.0	P 41.6471.2	P 41.6331.2	P 41.6317.2	P 41.6313.5	P 41.6321.6
Latón Pulido	 2 P 41.6326.4	P 41.6328.6	P 41.6330.1	P 41.6472.3	P 41.6332.3	P 41.6318.3	P 41.6314.6	P 41.6322.0

*En el caso de necesitar muletilla, indicar en el pedido la distancia del centro del cuadrado al centro de la muletilla para su mecanización



Uso intenso: Alta frecuencia de uso y probabilidad de uso indebido. Edificios públicos e institucionales; bibliotecas, hospitales y escuelas.
Durabilidad: 200.000 ciclos.
Resistencia al fuego: No.
Resistencia a la corrosión: Moderada (48 h).

ATELIER

PALLINE

Latón

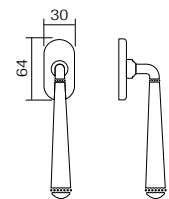
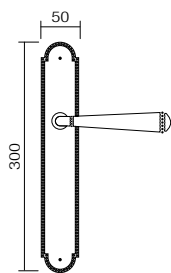
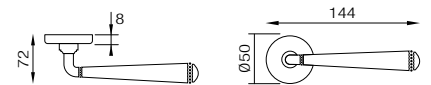

	Garantía		Roseta	Maneta placa	Maneta placa + Muletilla*	Grisans	Serreta Ø50 mm.	Borja Ø50 mm.	Mult. + Desb. Ø50 mm.
Níquel Brillo	2	2	P 41.6333.4	P 41.6337.1	P 41.6341.5	P 41.6345.2	P 41.6317.2	P 41.6313.5	P 41.6321.6
Latón Pulido	2	2	P 41.6334.5	P 41.6338.2	P 41.6342.6	P 41.6346.3	P 41.6318.3	P 41.6314.6	P 41.6322.0
Cromo Brillo	4	10	P 41.6335.6	P 41.6339.3	P 41.6343.0	P 41.6347.4	P 41.6319.4	P 41.6315.0	P 41.6323.1
Brunito	3	5	P 41.6336.0	P 41.6340.4	P 41.6344.1	P 41.6348.5	P 41.6320.5	P 41.6316.1	P 41.6324.2

*En el caso de necesitar muletilla, indicar en el pedido la distancia del centro del cuadrado al centro de la muletilla para su mecanización



Uso intenso: Alta frecuencia de uso y probabilidad de uso indebido. Edificios públicos e institucionales; bibliotecas, hospitales y escuelas.
Durabilidad: 200.000 ciclos. | **Resistencia al fuego:** No.
Resistencia a la corrosión: 2 Moderada (48 h). / 3 Elevada (96 h). / 4 Muy alta (240 h).



ATELIER

ELISABETH

Latón



	1 Pomo con roseta Ø50 mm.	1 Pomo sin roseta Ø8 mm.	1 pomo grisans	1 Pomo con placa	1 pomo con placa + muletilla*
 1					
Garantía					
Níquel Brillo	2 2	P 41.6391.6**	P 41.6403.4	P 41.6397.5**	P 41.6400.1**
Latón Pulido	2 2	P 41.6389.4**	P 41.6401.2	P 41.6395.3**	P 41.6398.6**
Cromo Brillo	4 10	P 41.6390.5**	P 41.6402.3	P 41.6396.4**	P 41.6399.0**

* En el caso de necesitar muletilla, indicar en el pedido la distancia del centro del cuadrado al centro de la muletilla para su mecanización

**Con muelle. Se venden unitariamente.



Uso intenso: Alta frecuencia de uso y probabilidad de uso indebido. Edificios públicos e institucionales; bibliotecas, hospitales y escuelas.
Durabilidad: 200.000 ciclos. | **Resistencia al fuego:** No.
Resistencia a la corrosión: **2** Moderada (48 h). / **4** Muy alta (240 h).



Mi Satori

CHEMIN DE FER

Made in Netherlands
Latón



El sistema Mi Satori permite combinar los componentes para formar el conjunto deseado



Uso medio: Lugares con alguna probabilidad de accidentes o uso indebido. Situaciones internas, oficinas y áreas donde hay acceso limitado al público general. | **Resistencia al fuego:** No. | **Resistencia a la corrosión:** Moderada (48 h).

Possibilidad de combinar roseta con muelle*: Ver gama DUAL. | **Importante:** Para rosetas sin muelle se precisa instalar de picaportes reforzados.



	1	Efecto Inox	Negro Mate	
Jgo. 2 Manillas		42.1191.1	42.1192.2	
Jgo. 2 Rosetas para manillas o muletillas Sin muelle		42.1182.6	42.1184.1	
Jgo. 2 Bocallaves		42.1185.2	42.1187.4	
	Serreta Borjas	42.1188.5	42.1190.0	
Muletilla + desbloqueo		42.1195.5	42.1196.6	
Jgo. 2 Placas para manillas Sin muelle		P 42.1244.5	P 42.1246.0	
Manilla en forma de T Sin roseta Unidad		42.1193.3	42.1194.4	
Manillón		42.1197.0	42.1198.1	
Pomo para mueble		46.4738.3		
Pomo para mueble		46.4740.5	46.5039.3	
Mecanismo DK Sin manilla		42.1170.1	42.1172.3	
Espanoleta cuerpo completo con varillas Sin manilla		Dcha. P 42.1226.1	P 42.1228.3	
	Izda. P 42.1231.6	P 42.1233.1		
Tirador embutido para puerta		42.1237.5		
Tirador embutido de péndulo para canto puerta		42.1224.6		
Bisagra de Latón		P 42.1241.2	P 42.1242.3	

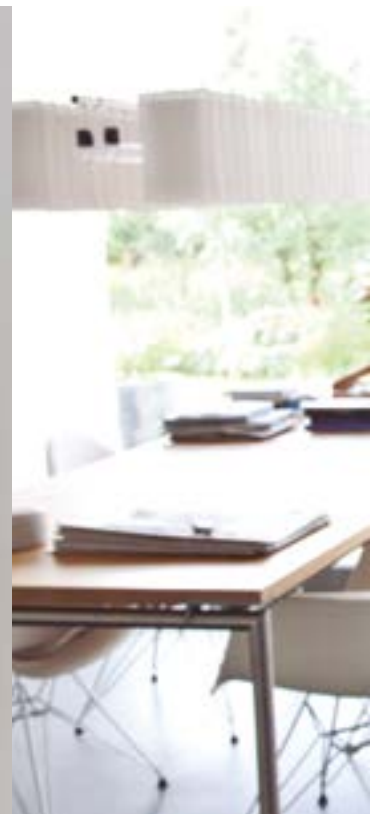

Mi Satori

FRANKFURT
Made in Netherlands
Latón

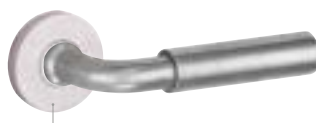

Posibilidad de montar
Roseta con muelle
(ver gama **DUAL**)

El sistema Mi Satori permite combinar los componentes para formar el conjunto deseado

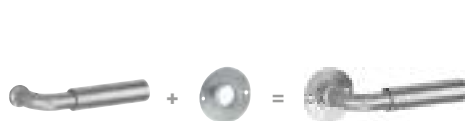

Uso medio: Lugares con alguna probabilidad de accidentes o uso indebido. Situaciones internas, oficinas y áreas donde hay acceso limitado al público general. | **Resistencia al fuego:** No. | **Resistencia a la corrosión:** Moderada (48 h).

Possibilidad de combinar roseta con muelle*: Ver gama DUAL.
Importante: Para rosetas sin muelle se precisa instalar de picaportes reforzados.



1		Efecto inox	Latón Natural	
Jgo. 2 Manillas		42.1180.4	P 42.1181.5	
Jgo. 2 Rosetas con tornillo visto para manillas o muletillas Sin muelle		42.1182.6	P 42.1183.0	
Jgo. 2 Bocallaves con tornillo visto Borjas		42.1185.2	P 42.1186.3	
Jgo. 2 Bocallaves con tornillo visto Serreta		42.1188.5	P 42.1189.6	
Muletilla + Desbloqueo Sin rosetas		P 42.1162.0	P 42.1163.1	
Jgo. 2 Placas para manillas Sin muelle		P 42.1244.5	P 42.1245.6	
Manillón		42.1197.0	P 42.1243.4	
Mecanismo DK Sin manilla		42.1170.1	P 42.1171.2	
Españoleta cuerpo completo con varillas Sin manilla		Dcha.	P 42.1226.1	P 42.1227.2
		Izda.	P 42.1231.6	P 42.1232.0
Tirador embutido para puerta		42.1237.5		
Tirador embutido de péndulo para canto puerta		42.1224.6		
Bisagra de Latón		P 42.1241.2	P 42.1239.0	



Mi Satori

DUAL

Made in Netherlands
Latón / Ébano



El sistema Mi Satori permite combinar los componentes para formar el conjunto deseado



200.000



3
AÑOS

Uso medio: Lugares con alguna probabilidad de accidentes o uso indebido. Situaciones internas, oficinas y áreas donde hay acceso limitado al público general.

Durabilidad roseta con muelle: 200.000 ciclos.

Resistencia al fuego: No.

Resistencia a la corrosión: Moderada (48 h).



Jgo. 2 Manillas		42.1153.5	P 42.1154.6	
Jgo. 2 Rosetas para manillas o muletillas *Con muelle <small>*Muelle facilmente extraible para usar como muletilla.</small>		42.1155.0	P 42.1156.1	
Jgo. 2 Bocallaves Borjas		42.1157.2	P 42.1158.3	
Jgo. 2 Bocallaves Serreta		42.1159.4	P 42.1160.5	
Muletilla + Desbloqueo Sin rosetas		42.1161.6	P 42.1162.0	
Jgo. 2 Placas para manillas Sin muelle		42.1167.5	P 42.1168.6	
Manillón Con rosetas		42.1174.5	P 42.1175.6	
Pomo para mueble		P 42.1176.0	P 42.1177.1	
Asa para mueble		P 42.1178.2	P 42.1179.3	
Mecanismo DK Sin manilla		42.1169.0	42.1170.1	
Espanoleta cuerpo completo con varillas Sin manilla		Dcha. P 42.1225.0 Izda. P 42.1230.5	P 42.1226.1 P 42.1231.6	
Tirador embutido para puerta		42.1236.4	42.1237.5	
Tirador embutido de péndulo para canto puerta		42.1223.5	42.1224.6	
Bisagra de Latón		P 42.1240.1	P 42.1241.2	



Mi Satori

BONTON

Made in Netherlands
Latón / Ébano



Roseta **Sin** muelle.



Roseta **Con** muelle.



El sistema Mi Satori permite combinar los componentes para formar el conjunto deseado



Uso medio: Lugares con alguna probabilidad de accidentes o uso indebido. Situaciones internas, oficinas y áreas donde hay acceso limitado al público general.
Durabilidad roseta con muelle: 200.000 ciclos. (Opción roseta sin muelle). | **Resistencia al fuego:** No.
Resistencia a la corrosión: Moderada (48 h). | **Importante:** Para rosetas sin muelle se precisa instalar de picaportes reforzados.



1

Níquel Brillo / Ébano Latón Brillo / Ébano

Jgo. 2 Manillas		42.1199.2	P 42.1200.3		
Jgo. 2 Rosetas para manillas o muletillas Sin muelle		P 42.1203.6	P 42.1204.0		
Jgo. 2 Rosetas para manillas o muletillas Con muelle		42.1205.1	P 42.1206.2		
*Muelle fácilmente extraíble para usar como muletilla.					
Jgo. 2 Bocallaves		42.1207.3	P 42.1208.4		
	Serreta Borijas	42.1209.5	P 42.1210.6		
Muletilla + Desbloqueo		42.1164.2	P 42.1165.3		
Jgo. 2 Placas largas Sin manillas		42.1211.0	P 42.1212.1		
Manilla en forma de T Sin roseta Unidad		42.1201.4	P 42.1202.5		
Manillón Con roseta		42.1213.2	P 42.1214.3		
Asa para mueble		P 42.1215.4	P 42.1216.5		
Mecanismo DK Sin manilla		42.1169.0	P 42.1173.4		
Españoleta cuerpo completo con varillas Sin manilla		Dcha.	P 42.1225.0	P 42.1229.4	
		Izda.	P 42.1230.5	P 42.1234.2	
Tirador embutido para puerta		42.1236.4	42.1235.3		
Tirador embutido de péndulo para canto puerta		42.1223.5	42.1222.4		
Bisagra de Latón		P 42.1240.1	P 42.1238.6		



Mi Satori

TON

Made in Netherlands
Latón / Teka



El sistema Mi Satori permite combinar los componentes para formar el conjunto deseado



Uso medio: Lugares con alguna probabilidad de accidentes o uso indebido. Situaciones internas, oficinas y áreas donde hay acceso limitado al público general.
Durabilidad roseta con muelle: 200.000 ciclos. (Opción roseta sin muelle).
Resistencia al fuego: No.
Resistencia a la corrosión: Moderada (48 h).

Jgo. 2
Manillas



42.1217.6

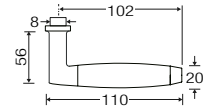

Jgo. 2
Rosetas para
manillas o
muletillas
Con muelle



42.1218.0

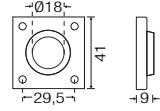

*Muelle fácilmente extraíble para usar como muletilla.

Jgo. 2
Bocallaves
Borjas



42.1219.1

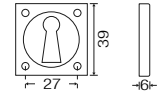

Jgo. 2
Bocallaves
Serreta



42.1220.2

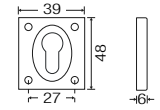

Muletilla +
Desbloqueo



42.1166.4

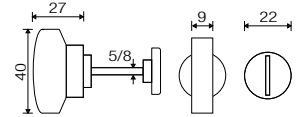

Jgo. 2
Placas
largas
Con manilla



42.1246.0

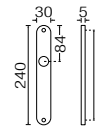

Manillón



42.1221.3

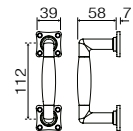

Mecanismo
DK
Sin manilla



42.1172.3

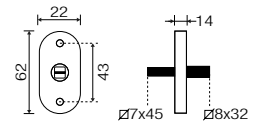

Espanoleta
cuerpo
completo
con varillas
Sin manilla



Dcha.

42.1228.3

Izda.

42.1233.1

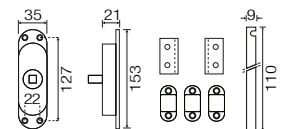

Bisagra
de Latón



42.1242.3

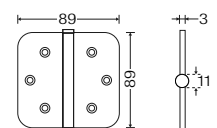

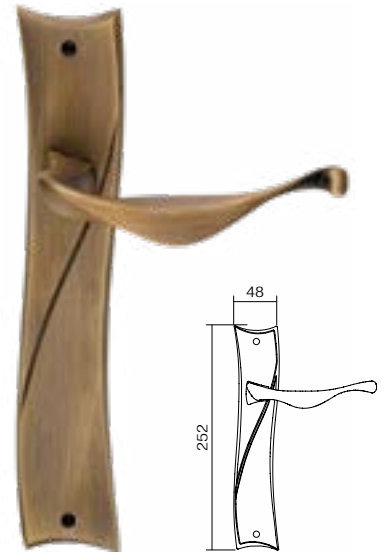

dnd

ARDEA
By Mauro Ronchi
Latón

1 Cuero Latón Patinado Pulido Brillo	Garantía 	Roseta 	Maneta placa 	Serreta 52x52 mm. 	Borjas 52x52 mm. 	Mult.+Desb. 52x52 mm.
	2 P 41.4515.6 5 P 41.4517.1	41.4518.2 P 41.4520.4	P 41.4512.3 P 41.6006.6	41.4513.4 P 41.6007.0	P 41.4514.5 P 41.6005.5	



Uso intenso: Alta frecuencia de uso y probabilidad de uso indebido. Edificios públicos e institucionales; bibliotecas, hospitales y escuelas.
Durabilidad: 200.000 ciclos. | **Resistencia al fuego:** Si. **Resistencia a la corrosión:** Elevada (96 h).

EN1906 3 7 - 2 0 0 0 B

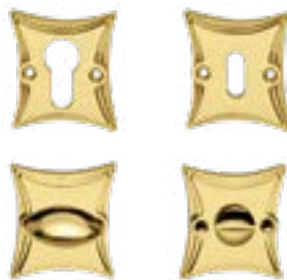
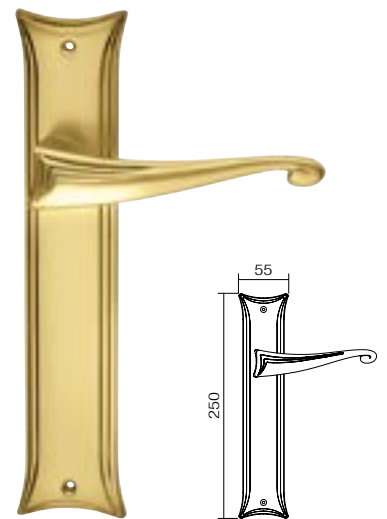

dnd

CASSIA
By Mauro Ronchi
Latón

1 Cuero Latón Patinado Pulido Brillo	Garantía	Roseta 	Maneta placa 	Serreta 53x61 mm. 	Borjas 53x61 mm. 	Mult.+Desb. 53x61 mm.
	2 P 41.4522.6 5 P 41.4521.5	P 41.4524.1 P 41.4523.0	P 41.6012.5 41.6010.3	41.6013.6 P 41.6011.4	P 41.6009.2 P 41.6008.1	

<p>3 EN1906</p>	<p>200.000</p>	<p>EN1634-2</p>	<p>GARANTÍA 2 AÑOS</p>	<p>GARANTÍA 5 AÑOS</p>
---------------------	----------------	-----------------	------------------------	------------------------

Uso intenso: Alta frecuencia de uso y probabilidad de uso indebido. Edificios públicos e institucionales; bibliotecas, hospitales y escuelas.
Durabilidad: 200.000 ciclos. | **Resistencia al fuego:** Si. **Resistencia a la corrosión:** Elevada (96 h).

dnd

Vive y trabaja en Villanuova sul Clisi, en la provincia de Brescia, donde fundó Studio Visual.

El diseño de Ronchi encuentra aplicación en muchos sectores: diseño industrial, gráfico, arquitectura de interiores, mobiliario, objetos para el hogar, iluminación, instalaciones y eventos.



Mauro Ronchi
Diseñador



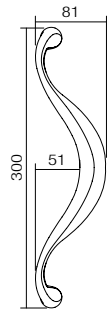
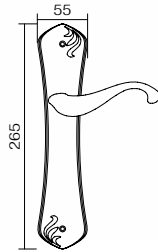
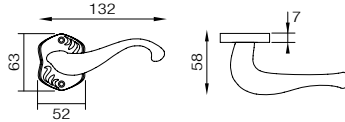

LATINA
By Mauro Ronchi
Latón

	Maneta	Maneta placa	Manillón	Serreta 52x63 mm.	Borjas 52x63 mm.	Mult.+Desb. 52x63 mm.	
Cuero Latón Patinado	Garantía 2	P 41.4031.5	41.4032.6	P 41.5921.5	41.4039.6	P 41.4037.4	41.4035.2

3 EN1906	 200.000	 EN1634-2	 GARANTÍA 2 AÑOS
--------------------	-------------	--------------	---------------------

Uso intenso: Alta frecuencia de uso y probabilidad de uso indebido. Edificios públicos e institucionales; bibliotecas, hospitales y escuelas.
Durabilidad: 200.000 ciclos. | **Resistencia al fuego:** Si. | **Resistencia a la corrosión:** Elevada (96 h).

EN1906 3 7 - 2 0 0 0 B

dnd

FIORENZA

By DND Technical Division
Latón

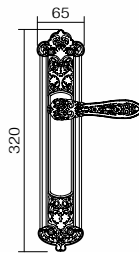
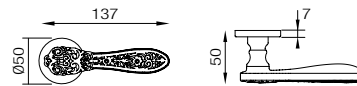
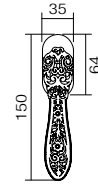

Cuero Latón Patinado
Oro francés

Garantía
2
5

Roseta



P 41.4895.1
P 41.4897.3

Maneta
placa



P 41.4899.5
P 41.4901.0

Grisans



P 41.5927.4
P 41.5928.5

Serreta
Ø50 mm.



P 41.4923.1
P 41.4927.5

Borjas
Ø50 mm.



P 41.4924.2
P 41.4928.6

Mult.+Desb.
Ø50 mm.



P 41.4919.4
P 41.4921.6

Bisagra
100x70 mm.



P 41.4917.2

Bisagra
125x90 mm.



P 41.4918.3



Uso intenso: Alta frecuencia de uso y probabilidad de uso indebido. Edificios públicos e institucionales; bibliotecas, hospitales y escuelas.
Durabilidad: 200.000 ciclos. | **Resistencia al fuego:** Si. **Resistencia a la corrosión:** Elevada (96 h).

EN1906 3 7 - 2 0 0 0 B

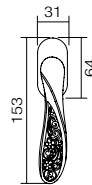
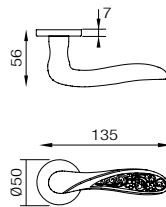
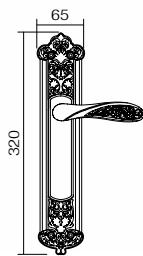
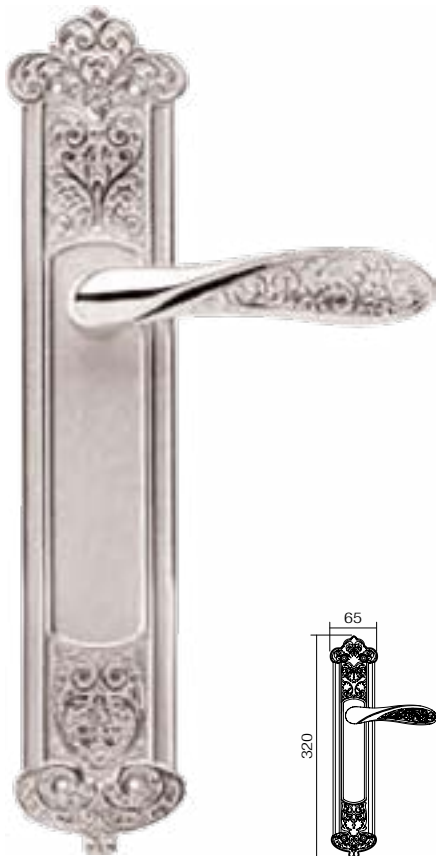

dnd

FIORE
By DND Technical Division
Latón



1
Cuero Latón Patinado
Oro francés
PVD Níquel Brillo

Garantía

3 2
3 5
4 10



Roseta
P 41.4903.2
P 41.4905.4
P 41.4904.3



Maneta placa
P 41.4907.6
P 41.4909.1
P 41.4908.0



Grisans
P 41.5929.6
P 41.5930.0
P 41.5931.1



Serreta
Ø50 mm.
P 41.4923.1
P 41.4927.5
P 41.4925.3



Borjas
Ø50 mm.
P 41.4924.2
P 41.4928.6
P 41.4926.4



Mult.+Desb.
Ø50 mm.
P 41.4919.4
P 41.4921.6
P 41.4920.5

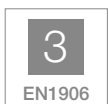

Uso intenso: Alta frecuencia de uso y probabilidad de uso indebido. Edificios públicos e institucionales; bibliotecas, hospitales y escuelas. | Durabilidad: 200.000 ciclos.
Resistencia al fuego: Si. | Resistencia a la corrosión: 3 Elevada (96 h.) / 4 Muy alta (240 h.)

EN1906 3 7 - 2 0 0 0 B

Línea ESTILOS

GAUDÍ

Latón



Izquierda

Derecha

1	Garantía	Jgo. roseta oval con muelle	Bocallave con placa	Muletilla y desbloqueo con placa		
Acabado 1	2	2	P 42.0752.3	P 42.0761.5 *	P 42.0755.6	P 42.0758.2
Acabado 2	3	5	P 42.0753.4	P 42.0762.6 *	P 42.0756.0	P 42.0759.3
Acabado 3	3	5	P 42.0754.5	P 42.0763.0 *	P 42.0757.1	P 42.0760.4

1	Garantía	Manillón con mano		
Acabado 1	2	2	P 42.0764.1	P 42.0767.4
Acabado 2	3	5	P 42.0765.2	P 42.0768.5
Acabado 3	3	5	P 42.0766.3	P 42.0769.6

*Especificar serreta o borjas



1	Garantía	Jgo. roseta con muelle	Jgo. maneta con muelle	Bocallave con placa	Muletilla con placa	Desbloqueo con placa	Mulet. +Desb. para instalación en maneta
Acabado 1	2	2	P 42.1066.2	P 42.1069.5	P 42.1078.0 *	P 42.1072.1	P 42.1084.6
Acabado 2	3	5	P 42.1067.3	P 42.1070.6	P 42.1079.1 *	P 42.1073.2	P 42.1085.0
Acabado 3	3	5	P 42.1068.4	P 42.1071.0	P 42.1080.2 *	P 42.1074.3	P 42.1086.1

*Especificar serreta o borjas



Uso medio: Lugares con alguna probabilidad de accidentes o uso indebido. Situaciones internas, oficinas y áreas donde hay acceso limitado al público general.

Durabilidad: 100.000 ciclos. | Resistencia al fuego: No. | Resistencia a la corrosión: 2 Moderada (48 h.) / 3 Elevada (96 h.)



Manillón



1

Garantía



200



H72

160

265

Sin placa

Con placa

Acabado 1 **2** **2**

P 42.0770.0

P 42.0749.0

Acabado 2 **3** **5**

P 42.0771.1

P 42.0750.1

Acabado 3 **3** **5**

P 42.0772.2

P 42.0751.2



Mirador

Mirilla interior

Placa para timbre



1

Garantía



175

175



115



70

70

Acabado 1 **2** **2** **P** 42.0746.4

P 42.0557.4

P 42.1081.3

Acabado 2 **3** **5** **P** 42.0747.5

P 42.0558.5

P 42.1082.4

Acabado 3 **3** **5** **P** 42.0748.6

P 42.0559.6

P 42.1083.5



Tipos de acabados disponibles Especificar en el pedido

2 Acabado 1: Pulido Brillo, Latón Mate, Latón Natural, Cuero Patinado o Bronce Inglés.

3 Acabado 2: Cromo Brillo, Cromo Mate, Níquel Brillo o Níquel Satinado.

3 Acabado 3: Baño de oro, Baño de plata o Baño de plata vieja.



LUÍS XV

Latón

	Jgo. maneta Con muelle		Manillón Con placa		Llamador	Mirador artesanal	Mirador	Mirilla interior
1	Garantía							
Acabado 1	2	P 42.0581.0	P 42.0584.3	P 42.0605.3	P 42.0608.6	P 42.0545.6	P 42.0554.1	P 42.0560.0
Acabado 2	3	P 42.0582.1	P 42.0585.4	P 42.0606.4	P 42.0609.0	P 42.0546.0	P 42.0555.2	P 42.0561.1
Acabado 3	5					P 42.0547.1	P 42.0556.3	P 42.0562.2
								P 42.0557.4
								P 42.0558.5
								P 42.0559.6



Uso medio: Lugares con alguna probabilidad de accidentes o uso indebido. Situaciones internas, oficinas y áreas donde hay acceso limitado al público general.

Durabilidad: 100.000 ciclos. | **Resistencia al fuego:** No. | **Resistencia a la corrosión:** 2 Moderada (48 h.) / 3 Elevada (96 h.)



REALIZAMOS SU PROYECTO A MEDIDA DESARROLLANDO Y FABRICANDO TODO TIPO DE HERRAJE ARTESANAL EN LATÓN

Diseño para hoteles, proyectos de decoración o reproducciones exactas de los modelos emblemáticos que precise para poder dar continuidad al estilo existente mediante diferentes métodos como la cera perdida, fundición a la tierra o torno. También realizamos restauración de baños sobre cualquier Material.

Usted pone el límite, nosotros se lo fabricamos.



MODERNISTA

Latón



Acabado 1

Garantía



Manillón Sin placa



42.1065.1

Manillón Con placa



42.1064.0

Mirador



42.1063.6

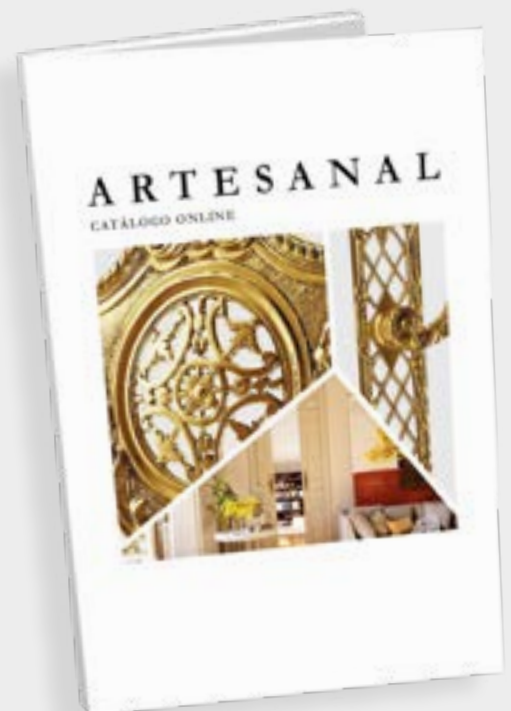

Tipos de acabados disponibles Especificar en el pedido

- 2 Acabado 1: Pulido Brillo, Latón Mate, Latón Natural, Cuero Patinado o Bronce Inglés.
- 3 Acabado 2: Cromo Brillo, Cromo Mate, Níquel Brillo o Níquel Satinado.
- 3 Acabado 3: Baño de oro, Baño de plata o Baño de plata vieja.

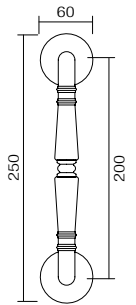
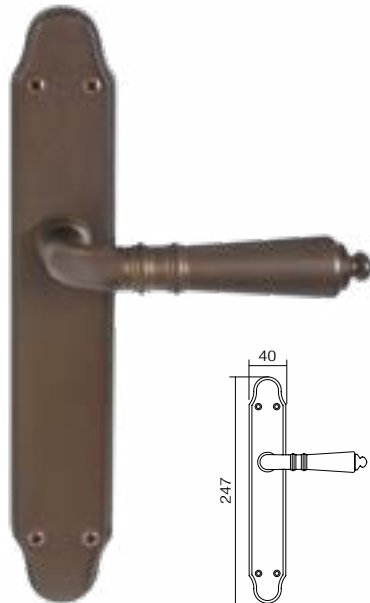

dnd

DANIELA
By DND Technical Division
Latón

1 **Garantía**

Pulido Brillo **3**
Brunito **2**

Maneta
placa



41.5905.3
41.5904.2

Manillón



41.5906.4
41.5907.5

Serreta
Ø50 mm.



41.4497.2
41.5940.3

Borja
Ø50 mm.



41.4496.1
41.5941.4

Mult. + Desb.
Ø50 mm.



41.4475.1
41.5932.2



Uso intenso: Alta frecuencia de uso y probabilidad de uso indebido. Edificios públicos e institucionales; bibliotecas, hospitales y escuelas. | **Durabilidad:** 200.000 ciclos.
Resistencia al fuego: Si. | **Resistencia a la corrosión:** Moderada (48 h).

EN1906 **3 7 - 2 0 0 0 B**

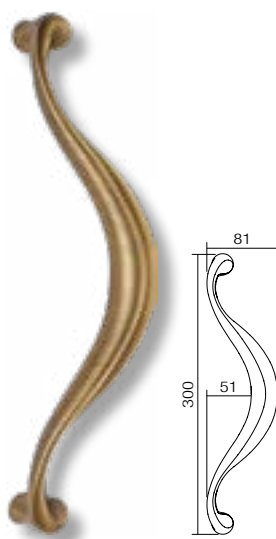

41.5921.5

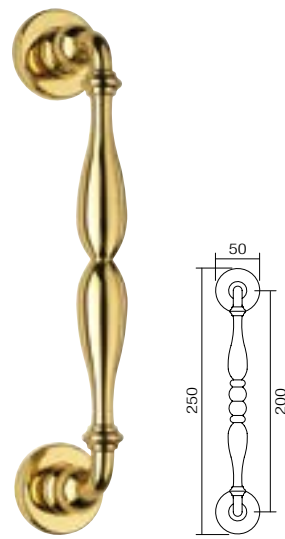

41.4792.3

dnd

CLASSIC

By DND Technical Division
Latón

1

Garantía

Roseta

Maneta placa

Manillón

Serreta
Ø50 mm.

Borja
Ø50 mm.

Mult. + Desb.
Ø35/50 mm.



Pulido Brillo

3

41.4791.2

P 41.4478.4

41.4792.3

41.4497.2

41.4496.1

41.4475.1

Cuero Latón Patinado

2

41.5909.0

41.5910.1

P 41.5921.5

41.4757.3

41.4763.2*

Ø35 mm.*



Uso intenso: Alta frecuencia de uso y probabilidad de uso indebido. Edificios públicos e institucionales; bibliotecas, hospitales y escuelas. | **Durabilidad:** 200.000 ciclos.
Resistencia al fuego: Si. | **Resistencia a la corrosión:** Moderada (48 h).

EN1906 3 7 - 2 0 0 0 B



KILTO
By Groël Lab
Latón

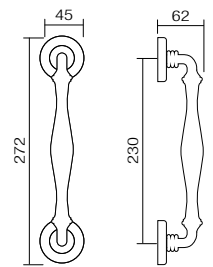

	Roseta	Manillón	Serreta Ø50 mm.	Borja Ø50 mm.	Mult. + Desb. Ø35/50 mm.
1					
Brunito	2 41.5812.1	41.5814.3	41.5940.3	41.5941.4	41.5932.2
Plata Envejecida	2 P 41.5813.2	P 41.5815.4	41.4759.5		41.4765.4* Ø35 mm.*

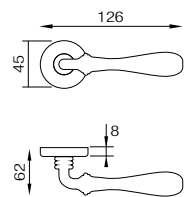

Uso intenso: Alta frecuencia de uso y probabilidad de uso indebido. Edificios públicos e institucionales; bibliotecas, hospitales y escuelas.
Durabilidad: 200.000 ciclos.
Resistencia al fuego: No. | **Resistencia a la corrosión:** Moderada (48 h).



dnd

LÍRICA

By DND Technical Division
Latón

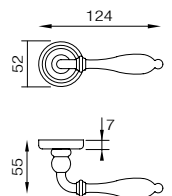
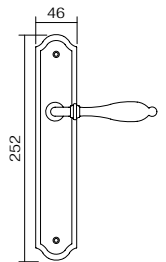

Pulido Brillo
Bronce Fumé

Garantía



41.5912.3

Maneta
placa



41.5914.5
41.5913.4

Serreta
Ø50 mm.



41.4497.2

Borja
Ø50 mm.



41.4496.1

Mult. + Desb.
Ø50 mm.



41.4475.1

3

EN1906



200.000



EN1634-2



2 AÑOS



3 AÑOS

Uso intenso: Alta frecuencia de uso y probabilidad de uso indebido. Edificios públicos e institucionales; bibliotecas, hospitales y escuelas. | **Durabilidad:** 200.000 ciclos.

Resistencia al fuego: Si. | **Resistencia a la corrosión:** Moderada (48 h).

EN1906 3 7 - 2 0 0 0 B



MARÍA
By Groël Lab
Latón

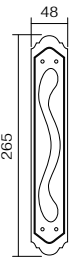
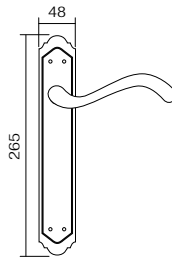
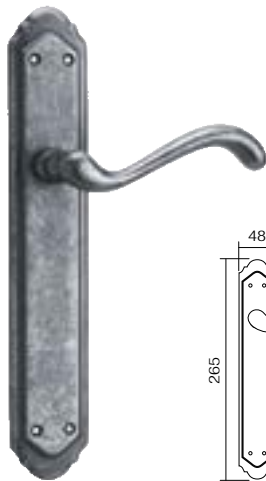

Roseta

Maneta
placa

Manillón

Serreta
Ø50 mm.

Borja
Ø50 mm.

Mult. + Desb.
Ø35/50 mm.



Garantía



Latón Mate-Brillo
Cuero Latón Patinado
Bronce Envejecido
Plata Envejecida

2
2
2
2

41.5816.5
41.5817.6
41.5818.0
41.5819.1

41.5820.2
41.5821.3
41.5822.4
41.5823.5

41.5824.6
41.5825.0
41.5826.1
41.5827.2

41.4497.2
41.4757.3
41.4758.4
41.4759.5

41.4496.1

41.4475.1
41.4763.2*
41.4764.3*
41.4765.4*
Ø35 mm.*

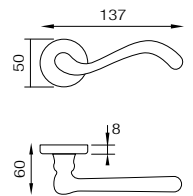

Uso medio: Lugares con alguna probabilidad de accidentes o uso indebido. Situaciones internas, oficinas y áreas donde hay acceso limitado al público general.
Durabilidad: 200.000 ciclos. | **Resistencia al fuego:** No. | **Resistencia a la corrosión:** Moderada (48 h).

EN1906 3 7 - 0 0 0 0 B



LEONOR

Latón

1/20

Garantía

Brillo Satinado

Cuero Inglés

2

2

Maneta



41.6694.1

41.6695.2



TAMARA

By Maheval Studio

Latón

1

Garantía

Brillo Satinado

2

Maneta



41.3044.5

Manillón



41.5639.3



POMOS ARMARIO Y MALETERO

Latón

1

Garantía

Brillo Satinado

Cuero Inglés

2

2

Pomo



41.6255.3

Pomo



41.6257.5

41.6258.6

TAMARA · POMOS ARMARIO · LEONOR



Uso ligero: Destinadas a lugares de baja ocurrencia de accidentes. Situaciones internas, oficinas, viviendas y áreas donde no hay acceso al público general.

Durabilidad: 200.000 ciclos.





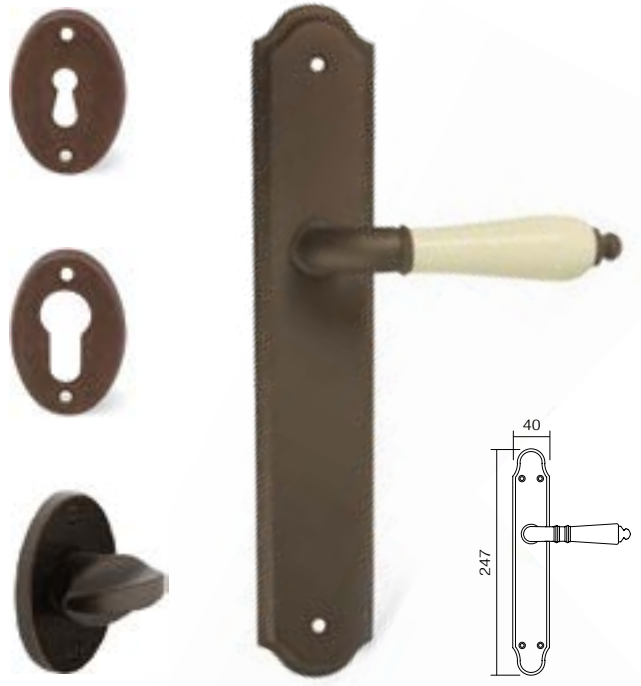

Resistencia al fuego: No. | **Resistencia a la corrosión:** Moderada (48 h).

dnd

DANIELA OVAL

By DND Technical Division
Latón / Porcelana









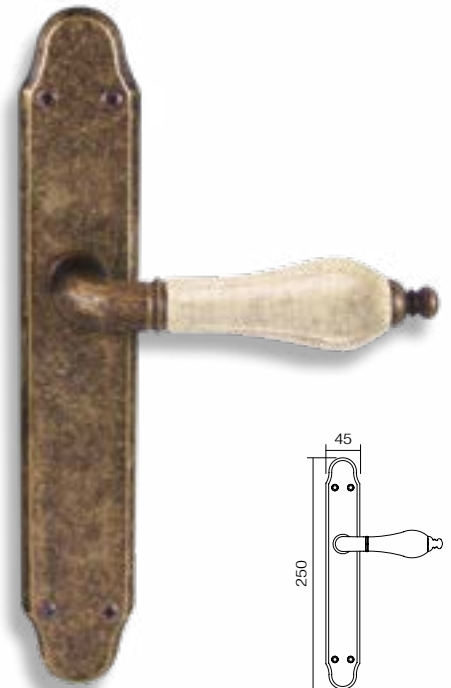

 1	Garantía	Roseta	Maneta placa	Serreta 60X40 mm.	Borja 60X40 mm.	Mult. + Desb. 60x40 mm.
						
Brunito / Porcelana 2	41.2967.5	41.3273.3	41.2969.0	41.2968.6	N 41.6985.8	

dnd

MÓNICA

By DND Technical Division
Latón / Porcelana



 1	Garantía	Roseta	Maneta placa	Serreta Ø50 mm.	Mult. + Desb. Ø35/50 mm.
					
Bronce Envejecido / Craquele Beige 2	41.5917.1	41.5919.3	41.4758.4	41.4764.3*	

*Diámetro de Ø35 mm.

3 EN1906	 200.000	 2 AÑOS
--------------------	--	--

Uso intenso: Alta frecuencia de uso y probabilidad de uso indebido. Edificios públicos e institucionales; bibliotecas, hospitales y escuelas.
Durabilidad: 200.000 ciclos. | **Resistencia al fuego:** No. | **Resistencia a la corrosión:** Moderada (48 h).

EN1906 3 7 - 0 0 0 0 0 B

LA BISBAL
Bronce y plata
Envejecida

By Work Studio
 Zamak / Porcelana



Garantía



Bronce Envejecido / Craquele Beige ②
 Plata Envejecida / Craquele blanco ②

Roseta
 41.5640.4
 41.5644.1

Maneta placa
 41.5641.5
 41.5645.2

Manillón
 41.6266.0
 41.6268.2

Manillón
 41.5642.6
 41.5646.3

Grisans
 41.5643.0
 41.5647.4

Serreta
 Ø50 mm.
 41.4758.4
 41.4759.5

Mult. + Desb.
 Ø35 mm.
 41.4764.3
 41.4765.4









Uso muy ligero: Manillas de bajo coste para puertas interiores de uso exclusivo en viviendas. Frecuencia baja de uso por personas cuidadosas y con poco riesgo de mala utilización.
Durabilidad: 100.000 ciclos.
Resistencia al fuego: No. | **Resistencia a la corrosión:** Baja (24 h).



ALBIN
Bronce y plata Envejecida
 By Work Studio
 Zamak



	Roseta	Maneta placa	Grisans	Serreta Ø50 mm.	Mult. + Desb. Ø35 mm.
 1					
Bronce Envejecido	2	41.4746.6	41.5633.4	41.4758.4	41.4764.3
Plata Envejecida	2	41.4749.2	41.5634.5	41.4759.5	41.4765.4









Uso muy ligero: Manillas de bajo coste para puertas interiores de uso exclusivo en viviendas. Frecuencia baja de uso por personas cuidadosas y con poco riesgo de mala utilización.
Durabilidad: 100.000 ciclos.
Resistencia al fuego: No. | **Resistencia a la corrosión:** Baja (24 h).



ALBIN
Negro Forja Envejecido
 By Work Studio
 Zamak



	Roseta	Manillón	Grisans	Serreta Ø50 mm.	Mult. + Desb. Ø35 mm.
 1					
Negro Forja	Garantía 2	41.6273.0	41.6275.2	41.6277.4	41.6280.0
		41.6279.6			



Uso muy ligero: Manillas de bajo coste para puertas interiores de uso exclusivo en viviendas. Frecuencia baja de uso por personas cuidadosas y con poco riesgo de mala utilización.
Durabilidad: 100.000 ciclos.
Resistencia al fuego: No. | **Resistencia a la corrosión:** Baja (24 h).

ALBIN CUERO

By Work Studio
Zamak



	Roseta	Maneta	Manillón	Grisans	Serreta Ø50 mm.	Mult. + Desb. Ø35 mm.
Cuero Latón Patinado 2	Garantía	41.4744.4	41.4745.5	41.6272.6	41.5632.3	41.4757.3
					41.4757.3	41.4763.2



PISA

By Work Studio
Zamak

	Maneta placa	Manillón	Grisans
Latón Brillo Satinado 2	Garantía	41.5625.3	41.5616.1
			41.5630.1

ALBIN CUERO · PISA



Uso muy ligero: Manillas de bajo coste para puertas interiores de uso exclusivo en viviendas. Frecuencia baja de uso por personas cuidadosas y con poco riesgo de mala utilización.
Durabilidad: 100.000 ciclos.
Resistencia al fuego: No. | **Resistencia a la corrosión:** Baja (24 h).



SELEC[®]
Luxury Lever Handle

ZK-ZEUS

By Selec D&D
Aluminio - Zamak

Roseta

Maneta
placa

Serreta
Ø50 mm.

Mult. + Desb.
Ø35 mm.

1/40

Garantía



Cuero Latón Patinado

2

41.4469.2

41.4470.3

41.4757.3

41.4763.2



Uso muy ligero: Manillas de bajo coste para puertas interiores de uso exclusivo en viviendas. Frecuencia baja de uso por personas cuidadosas y con poco riesgo de mala utilización.
Durabilidad: 100.000 ciclos.
Resistencia al fuego: No. | **Resistencia a la corrosión:** Baja (24 h).

LORCA
By Work Studio
Zamak



1	Garantía	Maneta placa H50 264	Manillón H50 265	Pomo H35 125	Pomo H35 83
Brillo Satinado	2	N 41.0204.6	N 41.0205.7	N 41.6508.4	N 41.6509.5
Cuero Inglés Mate	2	41.6473.4	41.6474.5	41.6475.6	41.6476.0



RUTE
By Work Studio
Chapa / Zamak

1/20	Garantía	Maneta placa H49 256	Manillón H49 256	Pomo H35 125	Pomo H35 83
Brillo Satinado	2	N 41.6506.2	N 41.6507.3	N 41.6508.4	N 41.6509.5

DONA
By Work Studio
Chapa Latón

1	Garantía	Maneta placa H46 248	Manillón H47 248
Pulido Brillo	2	41.4382.6	41.4383.0



LORCA · DONA · RUTE



Uso muy ligero: Manillas de bajo coste para puertas interiores de uso exclusivo en viviendas. Frecuencia baja de uso por personas cuidadosas y con poco riesgo de mala utilización.
Durabilidad: 100.000 ciclos.
Resistencia al fuego: No. | **Resistencia a la corrosión:** Baja (24 h).



FORJA

Línea HERRAJES DE FORJA

VALLADOLID

Maneta R/1100
Manillón con placa R/1101
Zamak



 1/2

41.0009.1 Negro

 1/2

41.0010.2 Negro

GRANADA

Pomo maletero R/28
Hierro forjado

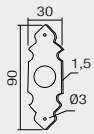

 1/25
41.4965.1 Negro
41.4966.2 Anticuario
 41.4967.3 Plata Vieja

GRANADA

Pomo armario R/30
Hierro forjado

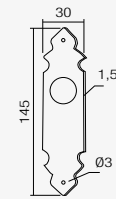

 1/25
41.4968.4 Negro
41.4969.5 Anticuario
 41.4970.6 Plata Vieja

TUDELA

Tirador anilla R/500-A | Tirador péndulo R/500-P
Hierro forjado

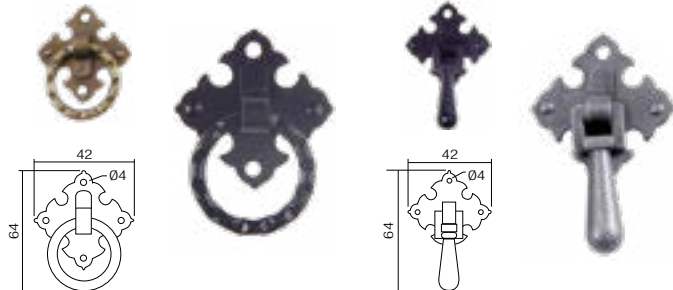

 1/25
41.5030.3 Negro
41.5031.4 Anticuario
41.5032.5 Plata Vieja

 1/25
41.5033.6 Negro
41.5034.0 Anticuario
41.5035.1 Plata Vieja

TUDELA

Asa pequeña movible R/113-P
Hierro forjado



 1/10
41.5015.2 Negro
41.5016.3 Anticuario
41.5017.4 Plata Vieja

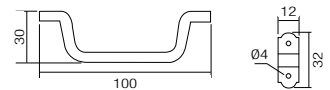

Uso inteso: Alta frecuencia de uso y probabilidad de uso indebido. Edificios públicos e institucionales; bibliotecas, hospitales y escuelas.
Durabilidad: 200.000 ciclos.
Resistencia al fuego: No.
Resistencia a la corrosión: Muy alta (240 h - Acabado Negro) / Moderada (48 h - Acabados Anticuario y Plata Vieja).

GRANADA

Maneta con placa R/240-105 | Tirador sin placa R/112-P y con placa R/112-L
Hierro forjado

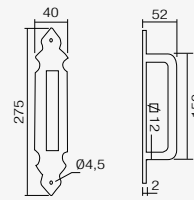
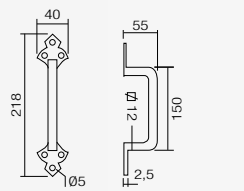
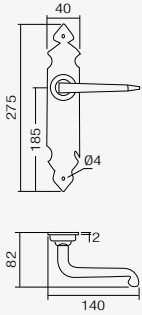

- 1/2 Manilla con placa
- 41.5044.3 Negro
 - 41.5045.4 Anticuario
 - P 41.5046.5 Plata Vieja

- 1/6 Manillón
- 41.5012.6 Negro
 - P 41.5013.0 Anticuario
 - P 41.5014.1 Plata Vieja

- 1/6 Manillón con placa
- 41.5009.3 Negro
 - 41.5010.4 Anticuario
 - P 41.5011.5 Plata Vieja

PAMPLONA

Roseta R/220-98
Maneta R/220-105
Y manillón con placa R/504-96
Hierro forjado

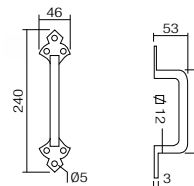
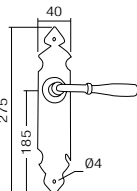
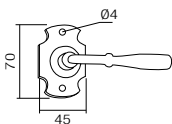

- 1/2 Roseta
- 41.5036.2 Negro
 - P 41.5037.3 Anticuario
 - P 41.5038.4 Plata Vieja

- 1/2 Manilla con placa
- 41.5041.0 Negro
 - P 41.5042.1 Anticuario
 - P 41.5043.2 Plata Vieja

- 1/6 Manillón
- 41.5039.5 Negro
 - P 41.5040.6 Anticuario
 - P 41.5124.6 Plata Vieja



Uso intenso: Alta frecuencia de uso y probabilidad de uso indebido. Edificios públicos e institucionales; bibliotecas, hospitales y escuelas.
Durabilidad: 200.000 ciclos.
Resistencia al fuego: No.
Resistencia a la corrosión: Muy alta (240 h - Acabado Negro) / Moderada (48 h - Acabados Anticuario y Plata Vieja).

Línea HERRAJES DE FORJA

ANDRATX

Hierro



Roseta

Maneta

Manillón

Grisans

Bocallave serreta oval

Muletilla y desbloqueo

Muletilla para placa

Pomo



Garantía



Óxido Corten* 2

41.6298.4

41.6297.3

41.6300.6

41.6299.5

41.6304.3

41.6302.1

41.6303.2

41.6301.0

*Con barniz de protección antimanchas por contacto.



Uso intenso: Alta frecuencia de uso y probabilidad de uso indebido. Edificios públicos e institucionales; bibliotecas, hospitales y escuelas.
Durabilidad: 200.000 ciclos.
Resistencia al fuego: No.
Resistencia a la corrosión: Muy alta (240 h).

PASADOR R/6

Hierro forjado

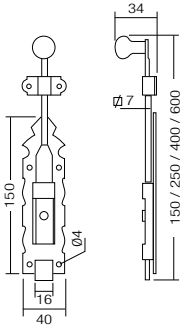

1/10	150 mm.	250 mm.	400 mm.	600 mm.
Negro	41.4941.5	41.4942.6	41.4943.0	P 41.6510.6
Anticuario	41.4944.1	41.4945.2	41.4946.3	P 41.6511.0
Plata Vieja	P 41.4947.4	P 41.4948.5	P 41.4949.6	P 41.6512.1

CERROJO R/84-R

Hierro forjado

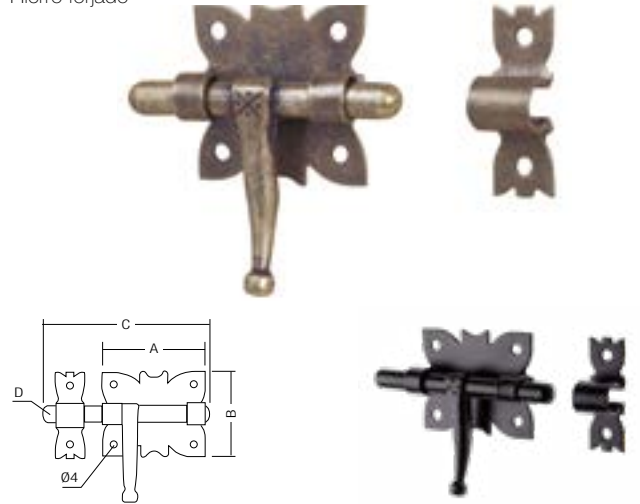

1/10	A	B	C	D	Negro	Anticuario	Plata Vieja
	40	42	65	Ø8	41.4994.2	41.4996.4	P 41.4998.6
	60	46	95	Ø9	41.4995.3	P 41.4997.5	P 41.4999.0

CERROJO R/85-R

Hierro forjado

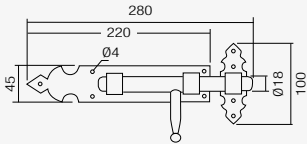

1/6	Color	Code
	Negro	41.5000.1
	Anticuario	41.5001.2
	Plata Vieja	P 41.5002.3

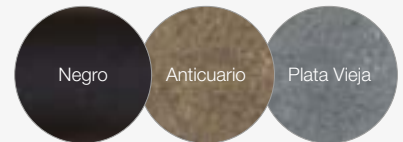

CERROJO DE SEGURIDAD CON CILINDRO

Incluye: Cilindro europeo de 50 mm.

Hierro



1	Derecha	Izquierda
Negro	34.4231.2	34.4232.3
Óxido	P 34.4229.0	P 34.4230.1
Oro*	P 34.4233.4	P 34.4234.5

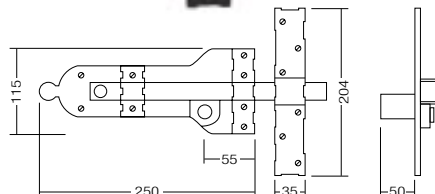

ALDABILLA SAN SEBASTIÁN R/1051

Hierro forjado



1/10	Color	Code
	Negro	41.5006.0
	Anticuario	P 41.5007.1
	Plata Vieja	P 41.5008.2

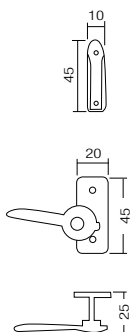

*Baño de Oro 18K

Línea HERRAJES DE FORJA

BISAGRA

Bisagra R/55 - R/55P
Hierro forjado

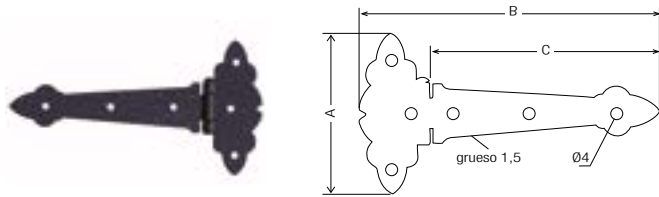

1/25	A	B	C	Negro	Anticuario	Plata Vieja
R/55 P	80	150	117	41.6516.5	41.6517.6	P 41.6518.0
R/55	92	180	140	41.6513.2	41.6514.3	P 41.6515.4

BISAGRA

Bisagra 245 x 110 mm R/50
Hierro forjado

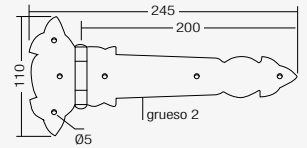

1/25	Negro	Anticuario	Plata Vieja
41.4974.3	Negro		
P 41.4975.4	Anticuario		
P 41.4976.5	Plata Vieja		

BISAGRA MARIPOSA

Bisagra R/60 - R/60P
Hierro forjado

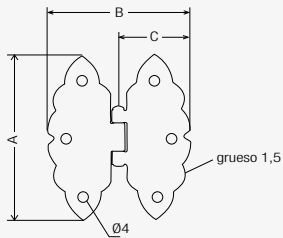

1/25	A	B	C	Negro	Anticuario	Plata Vieja
R/60 P	80	64	32	41.6522.4	41.6523.5	P 41.6524.6
R/60	92	80	40	41.6519.1	41.6520.2	P 41.6521.3

BISAGRA MARIPOSA

Bisagra 110 x 110 mm R/14
Hierro forjado

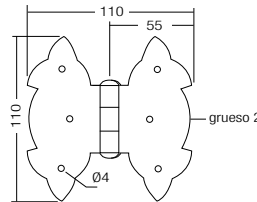

1/25	Negro	Anticuario	Plata Vieja
41.4950.0	Negro		
P 41.4951.1	Anticuario		
P 41.4952.2	Plata Vieja		

BISAGRA

Bisagra 76 x 23 mm R/11
Hierro forjado



1/25

41.0001.0	Negro
P 41.4939.3	Anticuario
P 41.4940.4	Plata Vieja

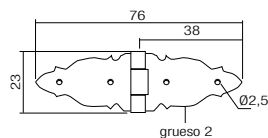

BISAGRA MARIPOSA

Bisagra 60 x 60 mm R/15-P
Hierro forjado



1/25

41.4986.1	Negro
P 41.4987.2	Anticuario
P 41.4988.3	Plata Vieja

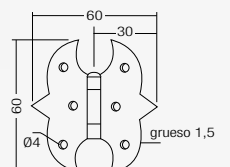

BISAGRA FUERTE

Bisagra 98 x 200 mm R/405
Hierro forjado

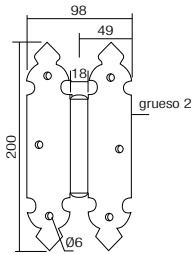

- 41.4989.4 Negro
- P** 41.4990.5 Anticuario
- P** 41.4991.6 Plata Vieja

BISAGRA SEGURIDAD

Bisagra 85 x 150 mm R/1530
Hierro forjado

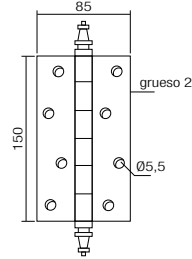

- 41.5018.5 Negro
- 41.5019.6 Anticuario
- 41.5020.0 Plata Vieja

BISAGRA GOLFO

Bisagra 290 x 200 mm R/24-CB
Hierro forjado

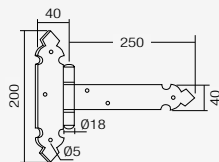
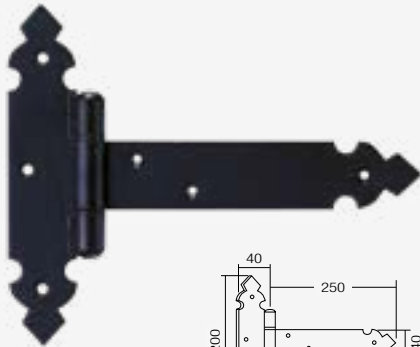

- 41.5021.1 Negro
- P** 41.5022.2 Anticuario
- P** 41.5023.3 Plata Vieja

PICAPORTE EMBUTIR

Reversible con condena R/2001
Hierro forjado

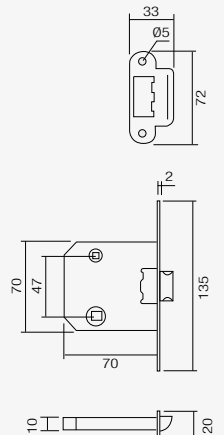

- 41.5049.1 Negro

MULETILLA R/42

Muletilla para puerta 35 mm.
Hierro forjado

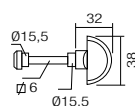

- 41.4971.0 Negro
- 41.4972.1 Anticuario
- P** 41.4973.2 Plata Vieja

PERNIO R/402-T

Pernio con final redondo R/402-T
Hierro forjado

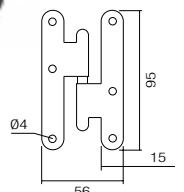

- | | | |
|-------------|----------------|------------------|
| | Derecha | Izquierda |
| Negro | 41.5024.4 | 41.5025.5 |
| Anticuario | 41.5026.6 | 41.5027.0 |
| Plata Vieja | 41.5028.1 | 41.5029.2 |

FELIPE II

Pomo de puerta R/125
Zamak

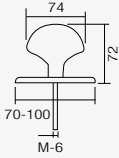

1/8

- 41.4983.5 Negro
- 41.4984.6 Anticuario
- 41.4985.0 Plata Vieja

LLAMADOR FELIPE II

Llamador R/622
Zamak

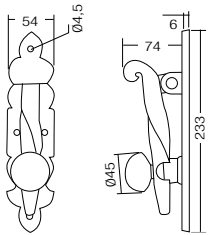

1/2

- 41.0232.0 Negro
- 41.4992.0 Anticuario
- 41.4993.1 Plata Vieja

BOCALLAVE

Serreta R/98-B
Hierro forjado

1/10

- 41.5003.4 Negro
- 41.5004.5 Anticuario
- 41.5005.6 Plata Vieja



CLAVO REDONDO

De Ø20 y Ø30 mm R/19
Hierro forjado



- | | Ø20 mm | Ø30 mm |
|-----------------|-----------|-----------|
| 25/200 Negro | 41.4953.3 | 41.4954.4 |
| 200 Anticuario | 41.4955.5 | 41.4956.6 |
| 200 Plata Vieja | 41.4957.0 | 41.4958.1 |

CLAVO CUADRADO

De 25 y 30 mm R/21
Hierro forjado



- | | 25x25 mm | 30x30 mm |
|-----------------|-----------|-----------|
| 25/100 Negro | 41.4959.2 | 41.4960.3 |
| 100 Anticuario | 41.4961.4 | 41.4962.5 |
| 100 Plata Vieja | 41.4963.6 | 41.4964.0 |

CLAVO Latón

De Ø35 mm
Latón



- 50
- 42.1087.2 Bronce Envejecido
- 42.1088.3 Latón Brillo
- 42.1089.4 Cuero Latón Patinado



CREMONA

Hierro forjado

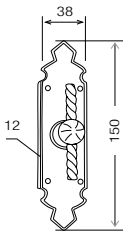
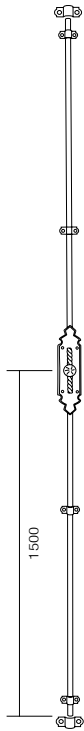

La varilla permite cortarse por la mitad para su uso superior e inferior

1/6	Negro	
Cremona	41.5121.3	
Varilla de 1500 mm	41.5608.0	

TORNILLO

Cabeza plana
Hierro forjado



50/1000	3,5x25 mm	3,5x30 mm	4x30 mm
Negro	41.5047.6	41.6483.0	41.5048.0

ESCUADRA ESTANTE

Escuadra decorativa R/73
Hierro forjado

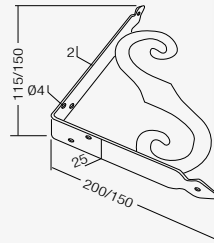

1/10	150x115 mm	200x150 mm
Negro	41.4977.6	41.4978.0
Anticuario	P 41.4979.1	P 41.4980.2
Plata Vieja	P 41.4981.3	P 41.4982.4

SOPORTE PASAMANOS R/883

Hierro forjado

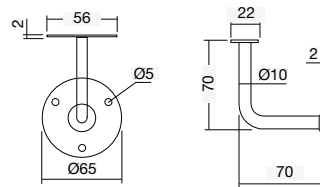

1/10	41.5125.0	Negro
	P 41.5126.1	Anticuario
	P 41.5127.2	Plata Vieja

HÉLICE

Hierro forjado

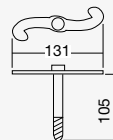

1	41.0895.5	Negro
---	------------------	-------

Pasos a seguir para pedidos falleba R/34, R/35 y R/36

Importante

Este producto se fabrica a medida. Para realizar el pedido háganos saber el código y los siguientes datos:

Tipo de apertura	Figura 1. Abre dentro	Figura 2. Abre fuera
Ø de la varilla	Ø 10 o 12 mm	
Largo total (A)	Altura hoja + altura de 1 marco	Altura hoja -5 mm
Altura maneta (B)	Desde el extremo inferior	
Mano	Derecha o izquierda	
Solapo/Tapabocas	En caso de llevar solapo/tapabocas, indicar medida	

Importante

Se facturará la medida inmediatamente superior a la elegida. Por ejemplo, de querer una falleba de Ø10 y 227 cm se facturaría la medida superior, es decir, Ø10 x 250 cm.

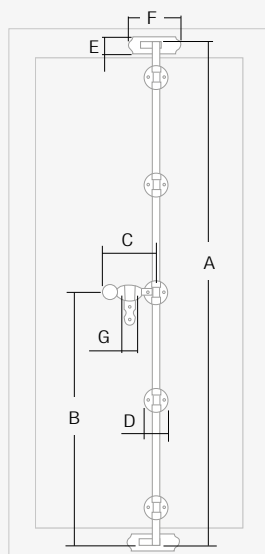

Ejemplo mano derecha



Figura 1.
Abre dentro

Figura 2.
Abre fuera

ESPAÑOLETA FALLEBA R/34

Hierro forjado



Medidas (en mm):

	Ø10	Ø12
A	-	-
B	-	-
C	85	100
D	43	45
E	32	32
F	95	115
G	20	25

1

	Ø10	Ø12
110 cms.	P 41.5052.4	P 41.5059.4
130 cms.	P 41.5053.5	P 41.5060.5
150 cms.	P 41.5054.6	P 41.5061.6
170 cms.	P 41.5055.0	P 41.5062.0
190 cms.	P 41.5056.1	P 41.5063.1
220 cms.	P 41.5057.2	P 41.5064.2
250 cms.	P 41.5058.3	P 41.5065.3
300 cms.		P 41.5066.4

Disponible en acabados especiales, consulte con nuestro departamento comercial

ESPAÑOLETA FALLEBA R/35

Hierro forjado



Medidas (en mm):

	Ø10	Ø12
A	-	-
B	-	-
C	92	92
D	43	45
E	32	32
F	95	115
G	25	25

1

	Ø10	Ø12
110 cms.	P 41.5067.5	P 41.5075.6
130 cms.	P 41.5068.6	P 41.5076.0
150 cms.	P 41.5069.0	P 41.5077.1
170 cms.	P 41.5070.1	P 41.5078.2
190 cms.	P 41.5071.2	P 41.5079.3
220 cms.	P 41.5072.3	P 41.5080.4
250 cms.	P 41.5073.4	P 41.5081.5
300 cms.		P 41.5082.6

Disponible en acabados especiales, consulte con nuestro departamento comercial

ESPAÑOLETA FALLEBA R/36

Hierro forjado



Medidas (en mm):

	Ø10	Ø12
A	-	-
B	-	-
C	92	92
D	30	30
E	30	30
F	146	146
G	30	30

Disponible en acabados especiales, consulte con nuestro departamento comercial

1	Ø10	Ø12
110 cms.	P 41.5083.0	P 41.5098.1
120 cms.	P 41.5084.1	P 41.5099.2
130 cms.	P 41.5085.2	P 41.5100.3
140 cms.	P 41.5086.3	P 41.5101.4
150 cms.	P 41.5087.4	P 41.5102.5
160 cms.	P 41.5088.5	P 41.5103.6
170 cms.	P 41.5089.6	P 41.5104.0
180 cms.	P 41.5090.0	P 41.5105.1
190 cms.	P 41.5091.1	P 41.5106.2
200 cms.	P 41.5092.2	P 41.5107.3
210 cms.	P 41.5093.3	P 41.5108.4
220 cms.	P 41.5094.4	P 41.5109.5
230 cms.	P 41.5095.5	P 41.5110.6
240 cms.	P 41.5096.6	P 41.5111.0
250 cms.	P 41.5097.0	P 41.5112.1
260 cms.		P 41.5113.2
270 cms.		P 41.5114.3
280 cms.		P 41.5115.4
290 cms.		P 41.5116.5
300 cms.		P 41.5117.6

Este producto se fabrica a medida. Para realizar el pedido háganos saber el código y los datos expresados en la página anterior. Las medidas hacen referencia al esquema de la página anterior.

GABASTRI

Españoleta Falleba
Hierro forjado

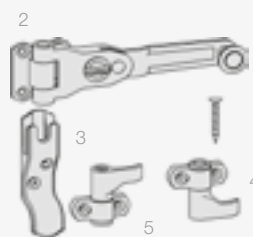

Juego de accesorios.

Composición:
- 1 manilla Nº 2.
- 1 bloqueo manilla Nº 3.
- 1 gancho derecha Nº 4.
- 1 gancho izquierda Nº 5.
- 10 tirafondos.

1

Kit accionamiento exterior 160 cms **34.3466.0**
Kit accionamiento exterior 320 cms **34.3467.1**
Kit accionamiento interior 160 cms **34.3468.2**
Kit accionamiento interior 320 cms **34.3469.3**
Soporte puente varilla Nº6 **34.2523.2**
Cerradero 2 puntas Nº8 **08.0633.4**

Regulable

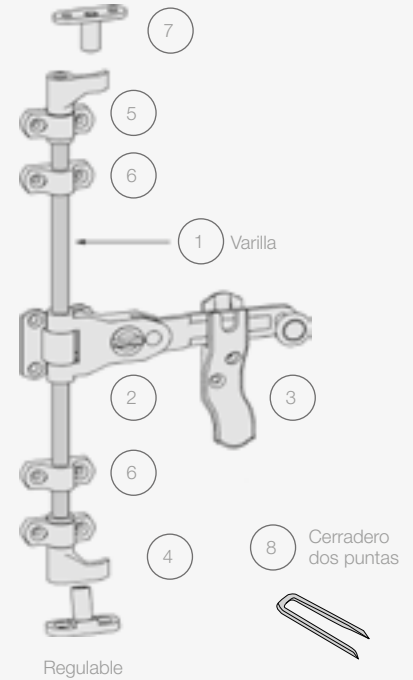

Regulable

Composición kit accionamiento exterior:

- 1 Juego de accesorios.
- 2 Soportes rectos regulables Nº7.
- 1 Varilla de 160 / 320 cms. (Ø9 mm) Nº1.
- 2 o 4 Soportes puente varilla Nº6.

Composición kit accionamiento interior*:

- 1 Juego de accesorios.
- 2 Cerraderos 2 puntas Nº8.
- 1 Varilla de 160 / 320 cms. (Ø9 mm) Nº1.
- 2 o 4 Soportes puente varilla Nº6.
- 1 Gancho cierre invertido derecha.
- 1 Gancho cierre invertido izquierda.

*Nota: En el montaje de accionamiento interior, los ganchos derecha Nº4 e izquierda Nº5 del juego de accesorios se deberán substituir por los ganchos de cierre invertido incluidos en el Kit.

Si lo desea puede solicitar más soportes puente varilla Nº6 para reforzar la instalación o más cerraderos 2 puntas Nº8 de recambio.



Gancho cierre invertido

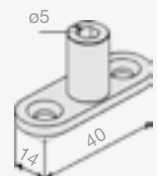

7 Soporte recto regulable

Negro

6 Soporte puente varilla





TÉCNICA



HC3 HA
DEMOSTRADO SER
EFICAZ CONTRA
MRSA Y E-COLI



REVESTIMIENTO ANTIBACTERIANO HC3

Prevención adicional contra bacterias en manillas para puertas, creando espacios saludables y protegiendo nuestro organismo.

Cuando las bacterias patógenas son transmitidas a los humanos, perjudicamos nuestra salud y nuestro organismo.

Esta situación se agrava notablemente, cuando nuestra salud es frágil, como en hospitales, residencias de tercera edad, guarderías, edificios o locales de alta concurrencia, etc..., pudiendo causar consecuencias drásticas.

En ambientes donde se proliferan las bacterias así como en zonas de alto tránsito de personas, la higiene de manos se considera la medida más importante

para reducir el riesgo de transmisión de microorganismos en los pacientes y visitantes, pudiéndose reducir las infecciones entre un 10 y un 50%, pero la realidad es que menos del 20% de los contactos con los pacientes cumplen estas directrices.

El sistema de revestimiento Antibacteriano HC3 elimina del 99,9% en Staphylococcus aureus y del 98,6% en E-Coli, incluidos los que están muertos, ayudando a prevenir los contagios.

Características principales HC3:

- Acción antibacteriana rápida y eficaz.
- Destruye los restos de las bacterias muertas.
- Autolimpieza (Superhydrophilicity).
- Invisible.
- No contiene microban o iones de plata.
- Resistente y duradero.
- Reduce el desgaste de los herrajes.

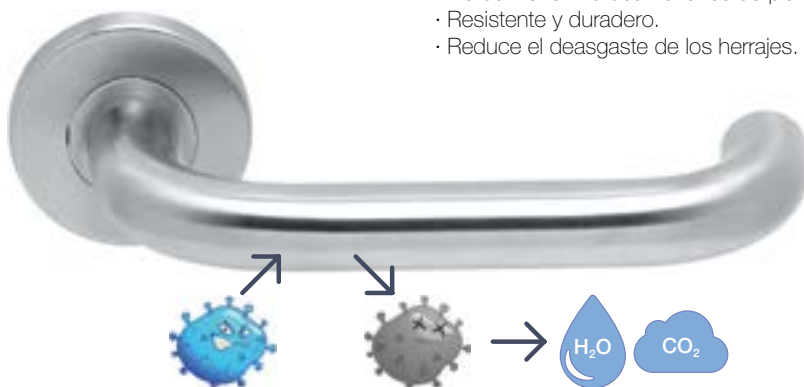

LA SOLUCIÓN

HC3 Revestimiento Antibacteriano: UNA PREVENCIÓN ADICIONAL

Los accesorios para puertas se usan cotidianamente y por lo tanto es un punto de transferencia clave para las bacterias.

Las primeras generaciones de herrajes antibacterianos no eran efectivos al 100% ya que, al fabricarse con elementos como cobre y plata, solo eliminaban a unas bacterias específicas y no eliminaban el resto.

HC3 es un revestimiento higiénico 3ª generación fabricado con métodos nanotecnológicos. Se trata de un recubrimiento resistente y duradero que elimina el 99,99% de bacterias y virus hospitalarios, incluso los que están muertos.

La base de este recubrimiento es titanio Dióxido (TiO2).

Al proteger los herrajes para puertas con el recubrimiento HC3, este problema puede ser resuelto al contener un elemento fotocatalítico innovador en lugar de los clásicos agentes químicos (biocidas).

Este elemento tiene la propiedad de trabajar como catalizador bajo la influencia de Luz UV (luz diurna o luz fluorescente) y utiliza un fenómeno físico para descomponerse.

¿Cómo funciona HC3?

La luz UV activa el recubrimiento de HC3, lo que hace que los electrones del recubrimiento comiencen a hacer su trabajo.

Estos electrones entran en contacto con las moléculas de agua (H2O), que siempre está presente en la atmósfera. Esto se descompone en dos radicales reactivos, superóxido (O2-) y hidroxilo (OH-). Estos radicales libres crean un efecto oxidante, que degradan los cuerpos orgánicos, como las bacterias y virus en el agua (H2O) y dióxido de carbono (CO2), que a su vez se entrega a la atmósfera.

Requisitos esenciales para el mejor rendimiento:

- Disponibilidad de luz UV.
- La fuente de luz debe estar sin filtrar.
- No limpiar con productos químicos agresivos.



Los herrajes con el revestimiento HC3 cuentan con 10 años de garantía certificada por el fabricante.



Revestimiento aplicable bajo demanda a productos ARTITEC. Consulte con nuestro departamento comercial para más información.

LEONA | CECIL | TAVIRA | NOA

By Artitec Lab.
Acero Inox AISI 304

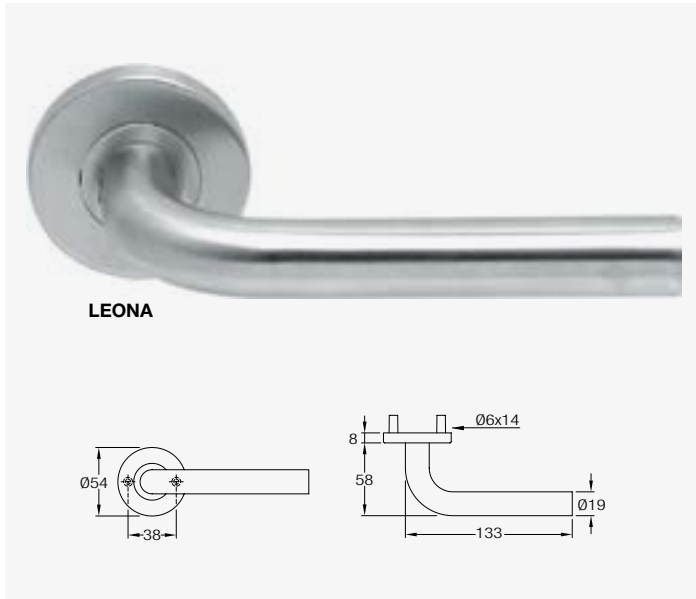

LEONA



CECIL

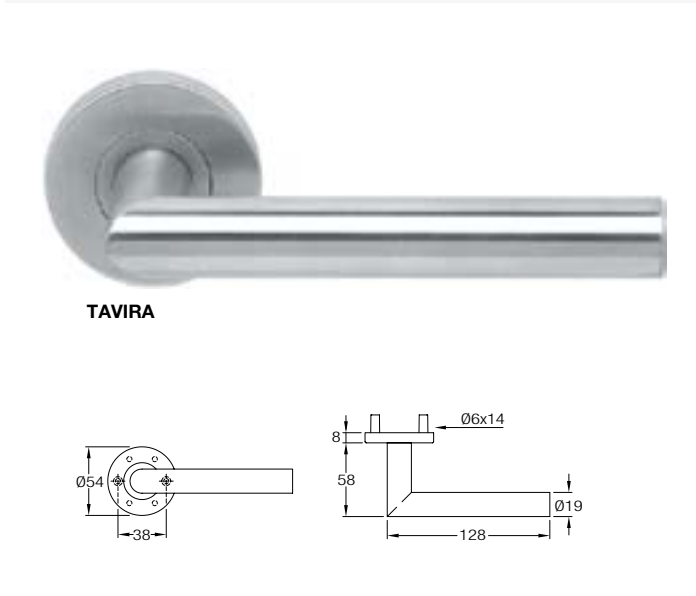

TAVIRA

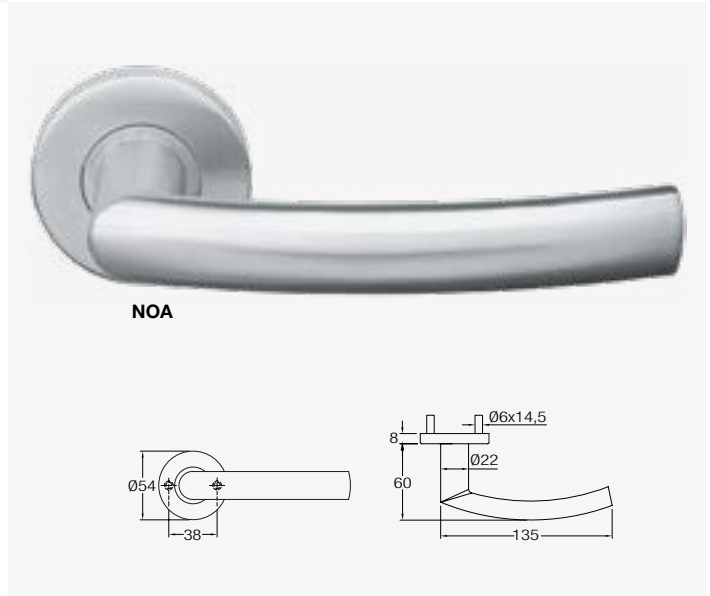

NOA



	LEONA	CECIL	TAVIRA	NOA	Serreta	Borja	Ciega	Mult. + Desb. libre / ocupado	Mult. + Desb. libre / ocupado
Garantía									
Inox Mate	5								
Code	42.1139.5	42.1140.6	42.1141.0	42.1142.1	41.2989.6	41.2990.0	41.4689.5	41.3124.1	41.3193.0



Uso intenso: Alta frecuencia de uso y probabilidad de uso indebido.
Edificios públicos e institucionales; bibliotecas, hospitales y escuelas.
Durabilidad: 200.000 ciclos. | **Resistencia al fuego:** Si. | **Resistencia a la corrosión:** Muy alta (240 h).

EN1906 3 7 - B 0 3 0 A



ARTITEC
Made in Netherlands

Homenaje al centenario **BAUHAUS**

BAUHAUS

By Artitec Lab.
Acero Inox AISI 304

Hemos querido realizar homenaje al centenario de la escuela de arquitectura, arte y oficios artísticos más influyente del siglo XX introduciendo en nuestro catálogo una manilla de líneas simples y geométricas que se convierte en atemporal.

La escuela Bauhaus creó un estilo que dinamizó los cánones previos y un modo de combinar la belleza artística de los objetos con su funcionalidad que trascendería épocas ya que un siglo después los diseños de la escuela siguen pareciendo modernos y actuales. Tuvo una vida breve de 14 años pero en ese tiempo influyó el diseño de todo el mundo.

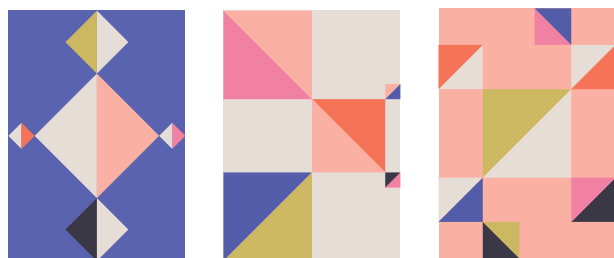

	Serreta	Borja	Ciega	Mult. + Desb.	Mult. + Desb. libre / ocupado
Inox Mate 5					
42.1143.2	41.2989.6	41.2990.0	41.4689.5	41.3124.1	41.3193.0

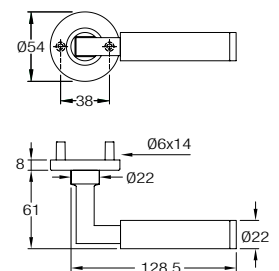

3 EN1906	 200.000	 EN1634-2	 5 AÑOS
--------------------	-------------	--------------	------------

Uso intenso: Alta frecuencia de uso y probabilidad de uso indebido. Edificios públicos e institucionales; bibliotecas, hospitales y escuelas.
Durabilidad: 200.000 ciclos. | **Resistencia al fuego:** Sí. | **Resistencia a la corrosión:** Muy alta (240 h).

EN1906 **3 7 - B 0 3 0 A**



CHASE



BODA



Indicador libre / ocupado.



CHASE
By Artitec Lab.
Acero Inox AISI 304

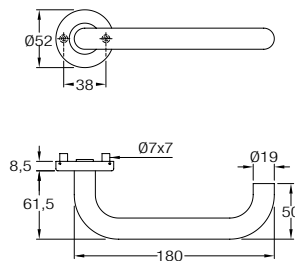

BODA
By Artitec Lab.
Acero Inox AISI 304

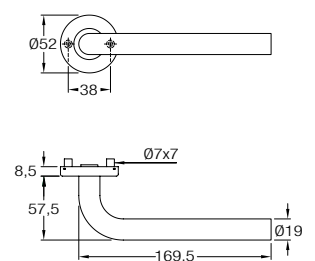

Inox Mate

Garantía

10

CHASE



42.1145.4

BODA



42.1144.3

Serreta



41.2989.6

Borja



41.2990.0

Ciega



41.4689.5

Mult. + Desb.



40.1986.3



Uso severo: Alta frecuencia de uso y probabilidad de uso violento. Edificios públicos e institucionales como estadios y baños públicos.

Durabilidad: 200.000 ciclos. | **Resistencia al fuego:** Si. | **Resistencia a la corrosión:** Muy alta (240 h).

EN1906 4 7 - B 1 3 0 B



Tornillos vistos en una sola cara

TESSA SLIMFACE



Tornillos vistos en una sola cara

BODA SLIMFACE



Indicador libre / ocupado.

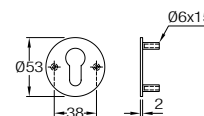

TESSA
SLIMFACE
By Artitec Lab.
Acero Inox AISI 304

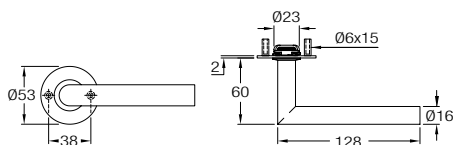

BODA
SLIMFACE
By Artitec Lab.
Acero Inox AISI 304

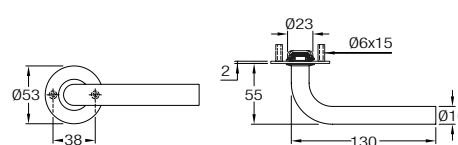

TESSA

BODA

Serreta
Jgo. 2 uds.

Borja
Jgo. 2 uds.

Mult. + Desb.
libre / ocupado



Garantía

Inox Mate

10



42.1147.6



P 42.1146.5



42.1148.0



42.1149.1



42.1150.2

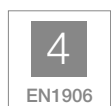

Uso severo: Alta frecuencia de uso y probabilidad de uso violento. Edificios públicos e institucionales como estadios y baños públicos.
Durabilidad: 200.000 ciclos. | **Resistencia al fuego:** Si. | **Resistencia a la corrosión:** Muy alta (240 h).

EN1906 4 7 - B 1 3 0 B



HERA



HADES





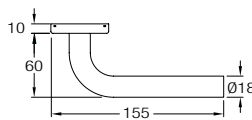

SELEC[®]
Luxury Lever Handle

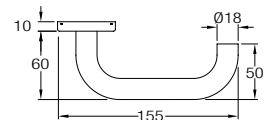
HERA
By Selec D&D
Acero Inox AISI 304







HADES
By Selec D&D
Acero Inox AISI 304



	Roseta	Roseta oval con muelle + 2 bocallaves	Maneta con o sin bocallave	Maneta de placa 1,5 mm. con o sin boca.
 1/10	 Garantía	 55		
Inox Mate	 5	41.2996.6	41.3878.6	41.3186.0
				41.4290.5*
			41.3187.1	41.4371.2*

*Bocallaves de serreta de 85 mm.

	Roseta	Maneta	Maneta de placa 1,5 mm. con o sin boca.
 1/10	 Garantía	 55	
Inox Mate	 5	41.3007.3	41.3188.2
			41.4410.6
			41.4411.0*

*Bocallaves de serreta de 85 mm.















AIDIMA

Uso intenso: Alta frecuencia de uso y probabilidad de uso indebido. Edificios públicos e institucionales; bibliotecas, hospitales y escuelas.
Durabilidad: 200.000 ciclos. | **Resistencia al fuego:** No.
Resistencia a la corrosión: Muy alta (240 h).



HERA · HADES

By Selec D&D
Acero Inox AISI 304

	Manillón con placa	Manillón con placa cuadrada	Manillón con roseta de 200 o 250 mm.	Placa de limpieza	Grisans	Pomo de armario	Serreta	Borjas	Mult.+Desb.	Mult.+Desb. libre / ocupado	Mult.+Desb. para placa	
 1/10	 Garantía											
Inox Mate	5	41.3192.6	41.3191.5	(200) 41.2998.1 (250) 41.3123.0	41.3190.4	41.3243.1	41.4784.2	41.2989.6	41.2990.0	41.3124.1	41.3193.0	41.3194.1



AIDIMA

Uso intenso: Alta frecuencia de uso y probabilidad de uso indebido. Edificios públicos e institucionales; bibliotecas, hospitales y escuelas.
Durabilidad: 200.000 ciclos. | **Resistencia al fuego:** No.
Resistencia a la corrosión: Muy alta (240 h).



HEBE



ERATO



SELEC[®]
Luxury Lever Handle

HEBE · ERATO
By Selec D&D
Acero Inox AISI 304

	HEBE Roseta	HEBE Maneta	ERATO Roseta	ERATO Maneta	Manillón sin roseta	Manillón con roseta	Serreta	Borjas	Mult.+Desb.	Mult. + Desb. libre / ocupado	
1/20 Garantía											
Inox Mate	5	41.3107.5	41.4014.2	41.3281.4	41.4015.3	41.4019.0	41.4018.6	41.2989.6	41.2990.0	41.3124.1	41.3193.0



AIDIMA

Uso intenso: Alta frecuencia de uso y probabilidad de uso indebido. Edificios públicos e institucionales; bibliotecas, hospitales y escuelas.
Durabilidad: 200.000 ciclos. | **Resistencia al fuego:** No.
Resistencia a la corrosión: Muy alta (240 h).



SELEC[®]
Luxury Lever Handle

QUIRÓN PLUS
By Selec D&D
Acero Inox AISI 304



	Roseta	Maneta	Manillón sin roseta de 200 ó 300 mm.	Manillón con roseta de 200 ó 250 mm.	Serreta	Borjas	Mult.+Desb.
Inox Mate							
	41.4075.0	41.4076.1	(200) 41.4079.4 (300) 41.4080.5	(200) 41.4077.2 (250) 41.4078.3	41.4090.1	41.4091.2	41.4092.3



AIDIMA

Uso intenso: Alta frecuencia de uso y probabilidad de uso indebido. Edificios públicos e institucionales; bibliotecas, hospitales y escuelas.
Durabilidad: 200.000 ciclos. | **Resistencia al fuego:** No.
Resistencia a la corrosión: Muy alta (240 h).



SELEC®
Luxury Lever Handle

HERACLES PLUS
By Selec D&D
Acero Inox AISI 304



		Maneta	Serreta	Borjas	Mult.+Desb.	Mult. + Desb. libre / ocupado
Inox Mate	5	41.3170.5	41.4683.6	41.2989.6	41.2990.0	41.3124.1 41.3193.0



AIDIMA

Uso intenso: Alta frecuencia de uso y probabilidad de uso indebido. Edificios públicos e institucionales; bibliotecas, hospitales y escuelas.
Durabilidad: 200.000 ciclos. | **Resistencia al fuego:** No.
Resistencia a la corrosión: Muy alta (240 h).



BASIC

SELEC®
Luxury Lever Handle

ECO-KRISTINA
By Selec D&D
Aluminio / Zamak



	Roseta	Maneta	Manillón	Serreta	Mult.+Desb.	
1/20						
Negro Mate	2	41.6627.4	41.6629.6	41.6630.0	41.6597.2	41.6601.6
Efecto Inox	2	N 41.6774.6	N 41.7016.6	41.6696.3	41.6732.4	41.4380.4



Uso muy ligero: Manillas de bajo coste para puertas interiores de uso exclusivo en viviendas. Frecuencia baja de uso por personas cuidadosas y con poco riesgo de mala utilización.
Durabilidad: 100.000 ciclos.
Resistencia al fuego: No.
Resistencia a la corrosión: Baja (24 h).

SELEC®
Luxury Lever Handle

RENTAL REDONDA

By Selec D&D
Aluminio / Zamak



	Maneta	Manillón redondo	Serreta	Borjas	Mult.+Desb.
Efecto Inox 2 Negro Mate 2	41.4154.2 41.6626.3	41.4081.6 41.6628.5	41.4289.4 41.6631.1 41.4649.0 41.6599.4	41.4481.0 41.6251.6	41.3800.5 41.6634.4

SELEC®
Luxury Lever Handle

RENTAL CUADRADA

By Selec D&D
Aluminio / Zamak



	Maneta	Manillón cuadrado	Serreta	Borjas	Mult.+Desb.
Efecto Inox 2	41.4098.2 41.4081.6	41.6014.0	41.6732.4	41.4091.2	41.4380.4



Uso muy ligero: Manillas de bajo coste para puertas interiores de uso exclusivo en viviendas. Frecuencia baja de uso por personas cuidadosas y con poco riesgo de mala utilización.
Durabilidad: 100.000 ciclos.
Resistencia al fuego: No.
Resistencia a la corrosión: Baja (24 h).

ZK-ZEUS
By Selec D&D
Aluminio / Zamak



	Roseta	Maneta	Manillón	Grisans	Serreta	Borjas	Mult.+Desb.
Efecto Inox	Garantía 2	52	242	200	32	62	
	41.3871.6	41.4095.6	41.4288.3	41.5629.0	41.4649.0	41.4481.0	41.3800.5

FAUS
By Selec D&D
Aluminio / Zamak



El juego de 2 manillones incluye Kit de fijación para instalación doble, simple y para instalación en puerta de cristal o madera.

	FAUS Roseta	FAUS Maneta	Kit 2 manillones	Serreta	Borjas	Mult.+Desb.
Efecto Inox	Garantía 2	52	200			
	41.3796.1	41.3798.3	41.5613.5*	41.4649.0	41.4481.0	41.3800.5

*Juego de 2 manillones sin rosetas



Uso muy ligero: Manillas de bajo coste para puertas interiores de uso exclusivo en viviendas. Frecuencia baja de uso por personas cuidadosas y con poco riesgo de mala utilización.
Durabilidad: 100.000 ciclos.
Resistencia al fuego: No.
Resistencia a la corrosión: Baja (24 h).



CORRREDEERAS

2800

HookyZERO +++



HOOKY ZERO REDONDO

Kit Cerradura + muletilla + dedal

Kit Cazoletas + dedal

Latón

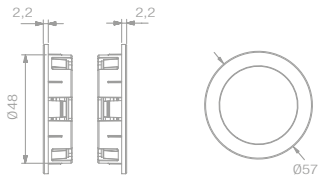
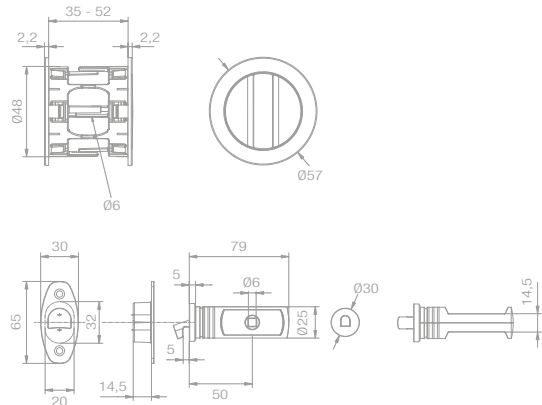

	1/36	Latón Pulido	Cromo Brillo	Cromo Mate	Negro Mate
①	Kit Cerradura	41.6577.3	41.6579.5	41.6580.6	41.6578.4
②	Kit Cazoleta	41.6584.3	41.6586.5	41.6587.6	41.6585.4



Montaje sin herramientas o siliconas



Rápida instalación

Esesor mínimo de la puerta 35 mm.



35 mm

Esesor máximo de la puerta 52 mm.



52 mm

Dispone de cerradero regulable $\pm 4,5$ mm.

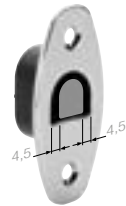

4,5



HOOKY ZERO CUADRADO

Kit Cerradura + muletilla + decal

Kit Cazoletas + decal

Latón

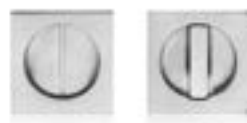
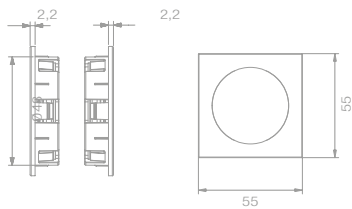
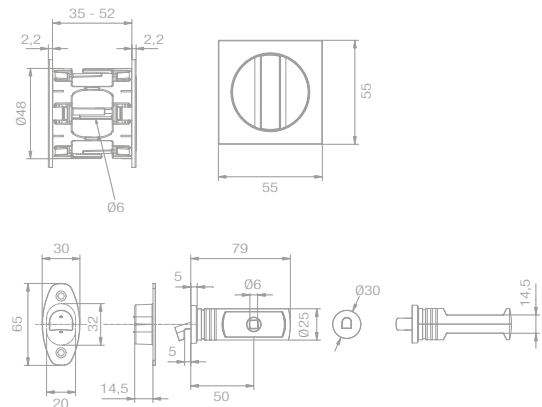

1/36

Cromo Brillo Cromo Mate Negro Mate

① Kit Cerradura	41.6582.1	41.6583.2	41.6581.0
② Kit Cazoleta	41.6589.1	41.6590.2	41.6588.0

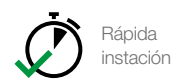

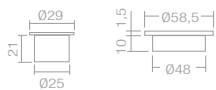
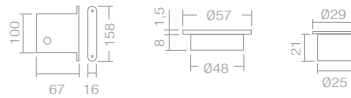

dnd

NOE
Dedal suelto
Latón



1
41.3599.0 Cromo Mate
41.3600.1 Efecto Inox
41.3597.5 Cuero



NOE

Kit Cerradura + muletilla + dedal redondo
Kit 2 Cazoletas ciegas redondas + dedal
Latón



1/10

Cromo Mate Cromo Brillo Latón Mate Pulido Brillo Bronce Envejecido Plata Envejecida Brunito Negro Mate Blanco Mate Antracita

① Kit Cerradura	41.5963.5	41.5962.4	41.5961.3	41.5960.2	41.5964.6	41.5966.1	41.5965.0	41.6295.1	41.6752.6	41.6777.9
② Kit Cazoleta	41.5989.3	41.5988.2	41.5987.1	41.5986.0	41.5990.4	41.5992.6	41.5991.5	41.6296.2	41.6753.7	41.6779.0



GARANTIA
10
AÑOS

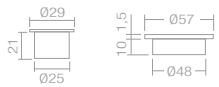
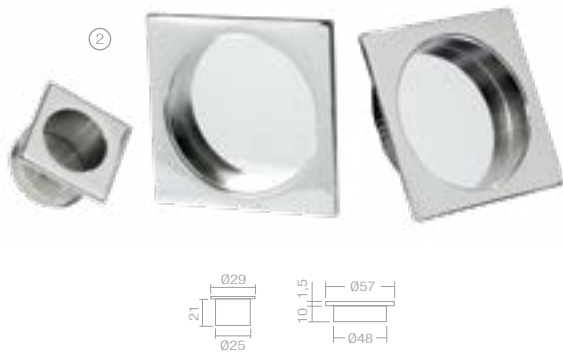
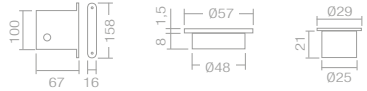

dnd

NIKO
Dedal suelto
Latón

1/25

41.6018.4
41.6019.5
41.6020.6

Cromo Mate
Cromo Brillo
Efecto Inox



groël
handle design

NIKO

Kit Cerradura + muletilla + dedal cuadrado
Kit 2 cazoletas ciegas cuadradas + dedal
Latón



1/10

① Kit Cerradura
② Kit Cazoleta

Cromo Mate

41.5977.5
41.5995.2

Cromo Brillo

41.5976.4
41.5994.1

Negro Mate

41.5978.6
41.5996.3

Blanco Brillo

41.5979.0
41.6740.5

Blanco Mate

41.6739.4
41.5997.4

Antracita

41.6780.1
41.6781.2

ECO-NIKO

Kit Cerradura + muletilla + dedal cuadrado
Zamak

Espesor mínimo puerta: 33 mm
Espesor máximo puerta: 50 mm

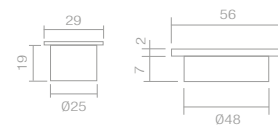
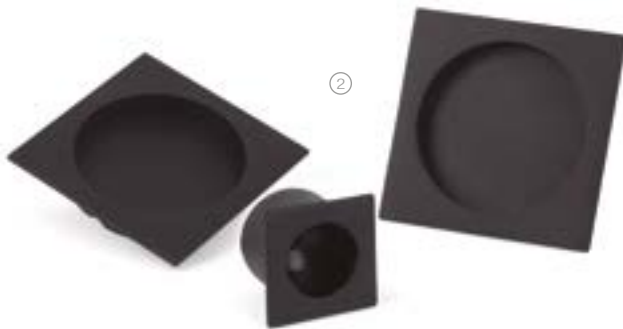
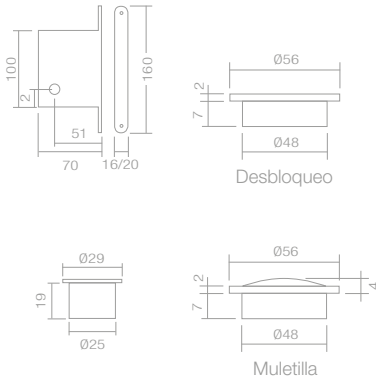

	Frente	Efecto Inox	Negro Mate
1			
① Kit Cerradura	16 mm.	41.4377.1	
① Kit Cerradura	20 mm.		41.6639.2
② Kit Cazoleta		41.6698.5	41.6640.3



CIRCLE

Kit Cerradura + muletilla + dedal redondo
Acero inoxidable EN 14301 / AISI 3044

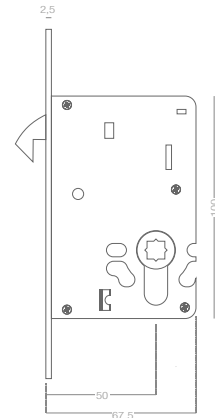
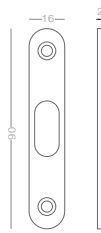

EN1906

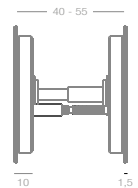
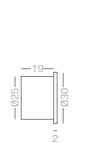

Inox
N 34.4521.3



Negro PVD (TB)
N 34.4522.4



Moka PVD (TCH)
N 34.4327.7



Dorado PVD (TCH)
N 34.4524.6

Ref. JNF
IN20915 + IN16310 + IN04240 1



ECO-QUADRA

Kit Cerradura + muletilla + dedal redondo
Acero inoxidable EN 14301 / AISI 304

Espesor mínimo de puerta: 35 mm.
Gancho, frente y cerradero en acero inox.
Cazoletas y dedal para embutir en zamak.

Certificación

EN12209 **2** B 4 0 0 B 2 C D 0 2

ECO

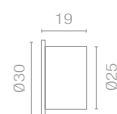
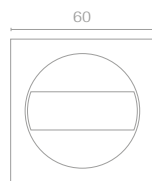
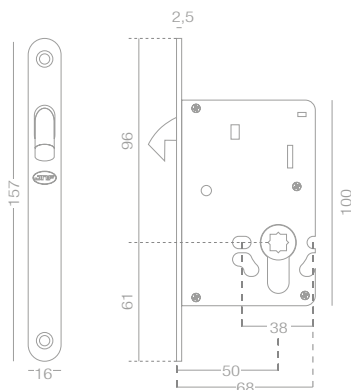

Ref. JNF
FN20938 1/30

Inox (NS)
N 34.4298.0

Negro (BA)
P N 34.4325.5

Bronce (LB)
P N 34.4327.7

MARE

Kit Cerradura + muletilla + dedal redondo
Acero Inoxidable

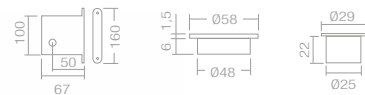

1/10
Inox Mate
41.5050.2



SAM

Con muelle
Acero Inoxidable



1
41.4798.2 Inox Mate Ø75 mm
46.4400.1 Inox Mate 155 x 45 mm



ERIC

Con muelle
Acero Inoxidable

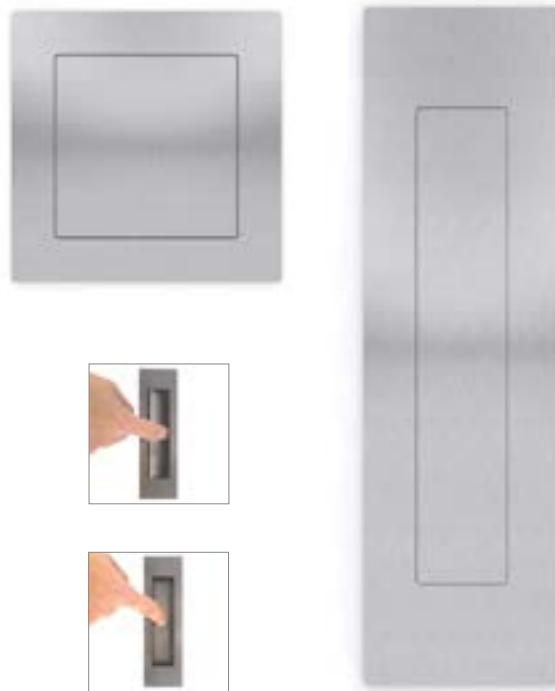

1
41.4799.3 Inox Mate 75 x 75 mm
46.4401.2 Inox Mate 155 x 45 mm





SLIDELOCK

Kit cerradura + muletilla + dedal redondo
y Kit tirador + dedal redondo
Acero Inoxidable



Inox Mate

41.4797.1 Kit cerradura + muletilla tirador + dedal redondo

41.6259.0 Kit tirador + dedal redondo

Video e instrucciones



reddot winner 2022





MAGNETLOCK

Kit de cerradura magnética y cazoleta accionable para puerta corredera

Cerradura magnética con cazoleta accionable enrasada para puertas correderas, sin apertura desde el exterior.

Basada en conceptos como la simplicidad del funcionamiento, formas básicas, ergonomía y fácil instalación.

De accionamiento y bloqueo silencioso.

Certificación:

EN 12209 **3 X 9 0 0 G 1 C G 0 0**

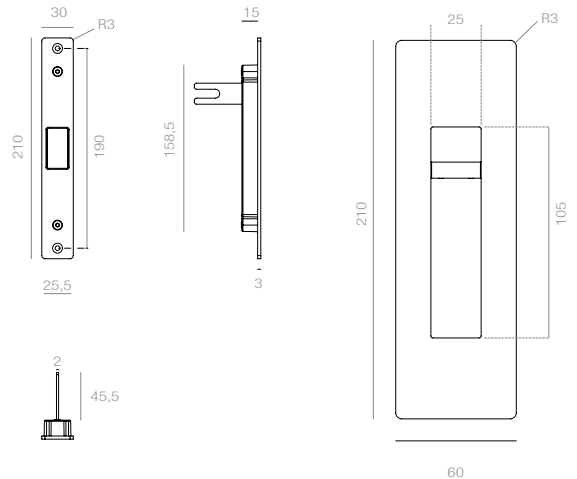

Ref. JNF	📦	Inox	Negro PVD (TB)	Moka PVD (TCH)	Dorado PVD (TG)
IN20925	1	N 94.0051.7	N 94.0052.8	N 94.0053.9	N 94.0055.0

S-Handle

Un asa minimalista que pasa desapercibida gracias a su instalación enrasada.

Un simple movimiento de inclinación crea una abertura para empujar o tirar fácilmente de la puerta para abrirla con una sola mano quedando totalmente integrada en la puerta.

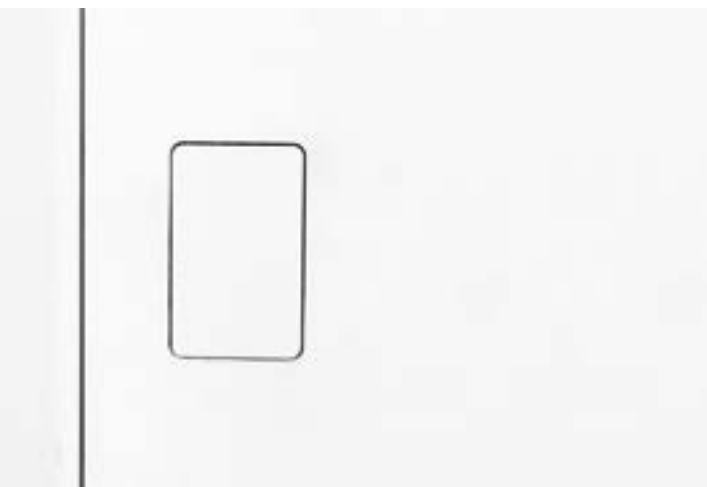

Vídeo de
instalación

QR



Sin tornillos de montaje o ajuste visibles.
 Aplicable universalmente para puertas izquierdas y derechas.
 La posición del asa se puede elegir libremente.
 Instalación por una o dos caras.
 Para puertas a partir de 40 mm.
 Ajustable en profundidad y en el eje de giro.

		Blanco Mate	Negro Mate	Plata
Jgo. de 2 asas S-Handle	1	N 40.0507.1	N 40.0508.2	P N 40.0509.3
		Puede pintarse		

Se sirven en juego de 2 unidades para poder instalarlo en ambas caras de la puerta aunque cabe la posibilidad de montarse solo por una cara.

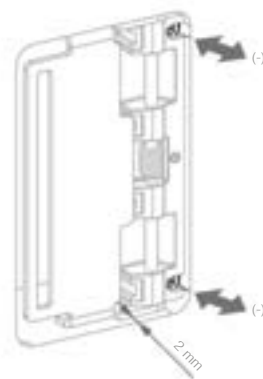

Regulación de **profundidad**

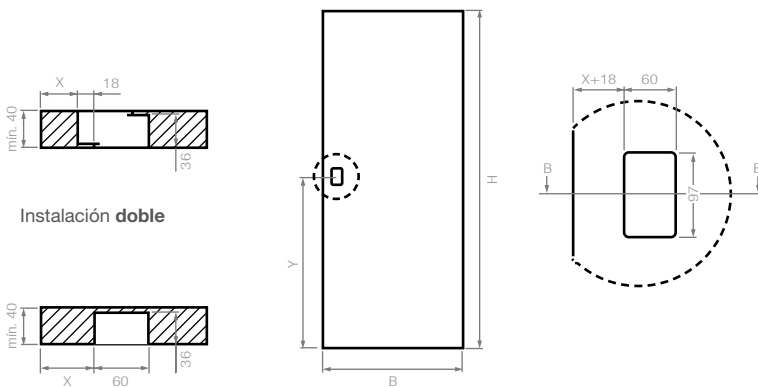

Instalación **doble**

Instalación **simple**

Fresado de las hojas

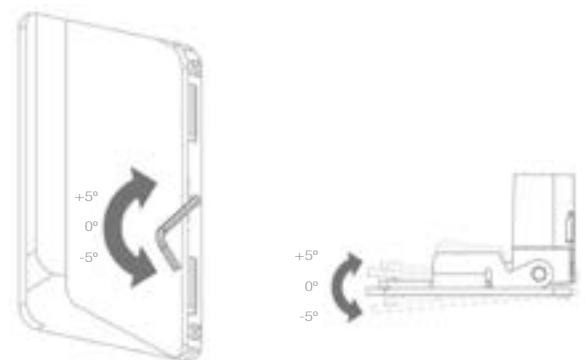

Regulación del **eje**

WAVE

Una empuñadura y cierre con el fin de ampliar los horizontes de los interioristas.

Un mecanizado para las dos versiones de cierre permite fabricar un solo panel estandarizado.

Rápido de montar, incluso después de la instalación, permite cambiar la solución de cierre en unos segundos.



Datos
Técnicos





Para puertas batientes de interior

1. La parte superior está dedicada al accionamiento y contiene el tirador móvil.
2. Una ligera presión sobre la muesca, descubre el pomo que permite bloquear y desbloquear la puerta (solo opción muletilla).
3. En la parte inferior aloja el cierre. Disponible la versión sin llave, baño o cilindro de perfil europeo.
4. El embellecedor se engancha con un sistema a presión.
5. Cerradura magnética para puertas interiores.

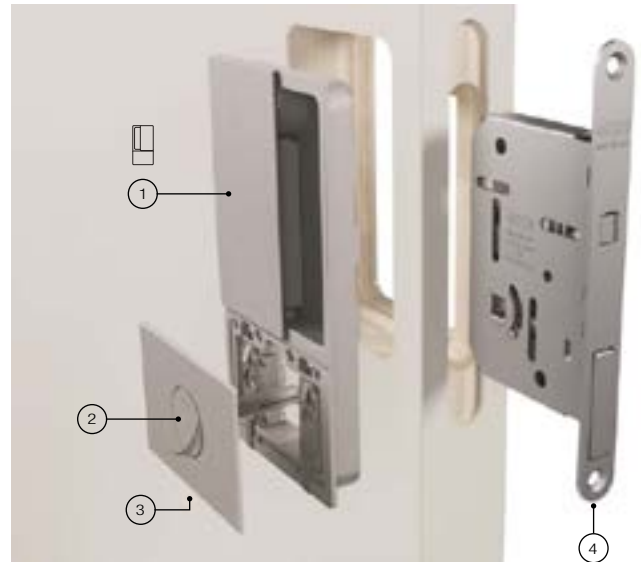

Para puertas correderas de interior

1. La parte superior contiene la empuñadura. A diferencia de Wave para Polaris, la manilla es fija y permite mover la hoja con facilidad.
2. Una ligera presión sobre la muesca, descubre el pomo que permite bloquear y desbloquear la puerta (solo opción muletilla).
3. En la parte inferior aloja el cierre. Disponible la versión sin llave, baño o cilindro de perfil europeo.
4. Cerradura para puerta corredera con tirador de arrastre integrado.



Cerradura puerta de paso
Magnética
Versión sin llave, baño o cilindro
Entrada 50

Cerradura puerta corredera
Con gancho y tirador
Versión sin llave, baño o cilindro
Entrada 50

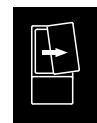
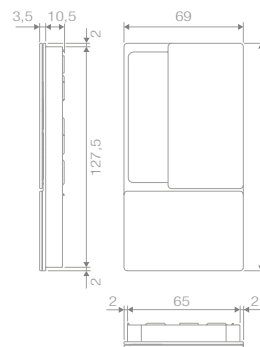

Puerta batiente
Wave Móvil

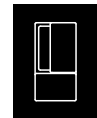

Puerta corredera
Wave Fija



3 acabados disponibles

Cerradero
Disponibles en los 3
acabados de la gama

Puertas Batientes

Descripción		Negro Mate	Blanco Mate	Cromo Mate
Jgo. Manilla	1/5	34.0090.2	34.0091.3	P 34.0089.1
Cerradura	1/20	34.0103.4	34.0104.5	P 34.0099.0
Jgo. Manilla Muletilla	1/5	34.0093.5	34.0094.6	P 34.0092.4
Cerradura Muletilla	1/20	34.0103.4	34.0104.5	P 34.0099.0
Jgo. Manilla Cilindro	1/5	34.0096.8	34.0097.9	P 34.0095.7
Cerradura Cilindro	1/20	34.0106.7	34.0107.8	P 34.0105.6
Cerradero universal	1/50	34.4108.5	34.4107.4	P 34.4106.3

Puertas Correderas

Descripción		Negro Mate	Blanco Mate	Cromo Mate
Jgo. Manilla	1/5	34.0110.0	34.0111.1	P 34.0108.9
Cerradura	1/20	34.0119.9	34.0121.0	P 34.0118.8
Jgo. Manilla Muletilla	1/5	34.0113.3	34.0114.4	P 34.0112.2
Cerradura Muletilla	1/20	34.0119.9	34.0121.0	P 34.0118.8
Jgo. Manilla Cilindro	1/5	P 34.0116.6	P 34.0117.7	P 34.0115.5
Cerradura Cilindro	1/20	P 34.0123.2	P 34.0124.3	P 34.0122.1

Línea CORREDERAS Asas al canto

LUNA

Acero Inoxidable

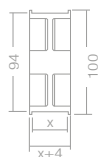

 1/5		
X	Inox Mate	Negro Mate
10 mm	41.3356.2	
12 mm	P 41.3357.3	
35 mm	41.3358.4	41.6650.6
40 mm	41.3359.5	41.6651.0
45 mm	P 41.3360.6	P 41.6652.1
50 mm	P 41.3361.0	
60 mm	P 41.3362.1	

EGEA

Acero Inoxidable



 1	
X	Inox
35 mm	41.4698.0
40 mm	41.4700.2

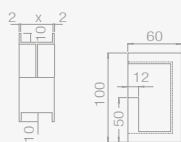

PORTO

Acero Inoxidable



 1	
X	Inox Mate
35 mm	41.6260.1
40 mm	41.6261.2
45 mm	P 41.6287.0
50 mm	P 41.6288.1

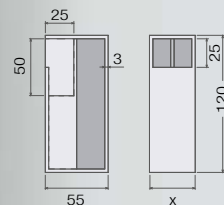



KUBE

Acero Inoxidable

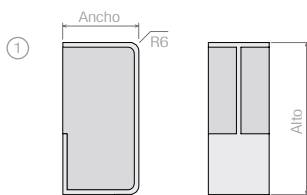

Sin pestaña y punto redondo

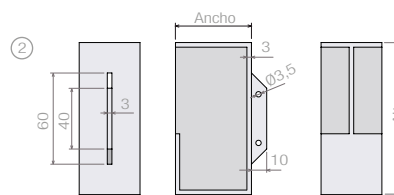

Con pestaña centradora y cantos rectos



Horizontal simulando las medidas de una manilla

📦 1	Ancho	Alto	Acabado	Para 10 mm	Para 35 mm	Para 40 mm	Para 45 mm	Para 50 mm
①	50	100	Negro Mate		N 41.6990.2	N 41.6991.3		
①	50	100	Inox Mate	P 41.3858.0	41.3859.1	41.3860.2	41.3861.3	P 41.3906.6
①	50	1100	Inox Mate		P 41.4058.4	P 41.4057.3	P 41.4056.2	
②	50	100	Negro Mate		41.6653.2	41.6654.3	41.6655.4	
②	50	100	Inox Mate		41.0179.3	41.0180.4	41.0206.8	
②	50	200	Inox Mate		41.6289.2	41.6290.3		
②	50	300	Inox Mate		41.6291.4	P 41.6292.5		
②	85	500	Inox Mate		P 41.6293.6	P 41.6294.0		
③	150	50	Inox Mate		P 41.6262.3	P 41.6263.4		

SLY RECTÁNGULO

Kit 2 placas

Fijación adhesiva no incluida,
solicitar aparte.

Acero Inoxidable

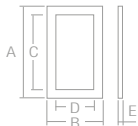

A	B	C	D	E	Acero Inox
85	50	65	20	6	46.4162.1
150	60	130	20	6	46.4165.4



SLY CUADRADO

Kit 2 placas

Fijación adhesiva no incluida,
solicitar aparte.

Acero Inoxidable

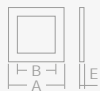

A	B	E	Acero Inox
50	30	6	46.4163.2
85	65	6	46.4164.3



SLY CÍRCULO

Kit 2 placas

Fijación adhesiva no incluida,
solicitar aparte.

Acero Inoxidable



A	B	E	Acero Inox
30	70	6	46.4168.0



SELEC[®]
Luxury Lever Handle

TOTE
By Selec
Acero Inoxidable

1/10	Encastre	Inox Mate	Negro Mate
50x50x2 mm	Ø40x11	46.4306.5	41.0030.8
70x70x2 mm	Ø53x11	46.4307.6	
150x50x2 mm	122x28x12	46.4308.0	
150x70x2 mm	137x57x12		41.0026.4
300x55x2 mm	280x35x16	41.0028.6	41.0027.5

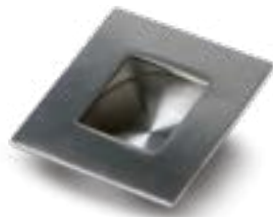

KOBE
Acero Inoxidable



1/10 **50x50 mm**
(mecanizado circular Ø40 mm)
46.4595.0 Inox Mate



SELEC[®]
Luxury Lever Handle

JAN
By Selec
Acero Inoxidable



1/10	⊙	1/20	⊏
46.2324.4	Inox Mate	46.2325.5	Inox Mate
41.0031.9	Negro Mate	41.0029.7	Negro Mate

Línea CORREDERAS Cazoletas

NOE OVAL

Zamak



Exterior	Encastre		Latón Oxidado	Efecto Inox Mate	Dorado Brillo	Cromo Brillo	Cromo Mate	Blanco
150x40	103x26x11	1/25	46.4910.0	46.4909.6	46.4912.2	46.4913.3	46.4914.4	46.4911.1

MUNICH

Zamak

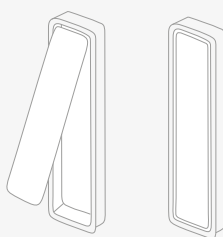

1/25

40.2220.6



Cromo Look



CLOS

Zamak



41.6528.3
46.6527.2



Negro Mate
Blanco Mate



IRIS

Zamak

Permite cortarse a medida



46.4628.5 Cromo Look
46.4698.5 Negro Mate
46.4697.4 Blanco Mate



TITO

Zamak



46.4629.6 Cromo Look
46.4881.6 Negro Mate
46.4882.0 Blanco Mate



TIFANY

Zamak



Exterior	Encastre	Inox Mate
150x25	145x20x11	46.4661.3
240x25	235x20x11	46.4662.4



CUBIC

Zamak



41.6526.1	Negro Mate
46.6525.0	Blanco Mate



LOW

Zamak



Exterior	Encastre	Cromo Brillo	Efecto Inox Brillo
78x52	60x46x13,5		41.5677.6
240x25	182x46x13,5	41.5678.0	41.5679.1

PLEC

Acero Inoxidable



Exterior	Inox Mate
75x75x6	41.5728.1
150x75x6	41.5729.2

Incluye adhesivo 3M. También permite instalarse adhesivo ultravioleta

i-1630

Juego de 2 manillones
Acero Inoxidable

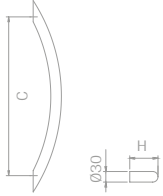

No apto para cristal

Fijación Doble	
C	H
250	66
300	70
350	74
450	80
600	80

1

C	H
250	66
300	70
350	74
450	80
600	80

Kit fijación doble incluido

i-1630

Manillón suelto
Acero Inoxidable

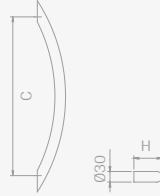

No apto para cristal

Fijación Simple Vista		Fijación Simple Oculta	
C	H		
250	66		
300	70		
350	74		
450	80		
600	80		

1

C	H
250	66
300	70
350	74
450	80
600	80

Kit de fijación simple Vista o Oculta incluido

i-2000

Juego de 2 manillones
Acero Inoxidable

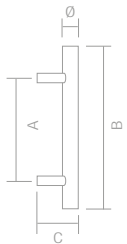

Fijación Doble			
Ø	A	B	C
20	200	300	65
20	250	400	65
20	300	450	65
20	500	700	65
20	800	1.000	65
20	1.000	1.200	65
30	250	550	90
30	450	750	90
30	650	950	90

1

Ø	A	B	C
20	200	300	65
20	250	400	65
20	300	450	65
20	500	700	65
20	800	1.000	65
20	1.000	1.200	65
30	250	550	90
30	450	750	90
30	650	950	90

Kit de fijación doble incluido

i-2000

Manillón suelto
Acero Inoxidable

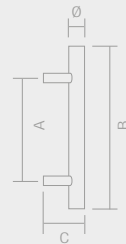

Fijación Simple Vista		Fijación Simple Oculta	
Ø	A	B	C
20	200	300	65
20	250	400	65
20	300	450	65
20	500	700	65
20	800	1.000	65
20	1.000	1.200	65
30	250	550	90
30	450	750	90
30	650	950	90
30	900	1200	90
30	1200	1500	90
30	1500	1800	90
30	1700	2000	90
30	1900	2200	90

1

Ø	A	B	C
20	200	300	65
20	250	400	65
20	300	450	65
20	500	700	65
20	800	1.000	65
20	1.000	1.200	65
30	250	550	90
30	450	750	90
30	650	950	90
30	900	1200	90
30	1200	1500	90
30	1500	1800	90
30	1700	2000	90
30	1900	2200	90

* Incluye los dos tipos de fijación.
Kit de fijación simple Vista o Oculta incluido.

i-3310

Juego de 2 manillones
Acero Inoxidable

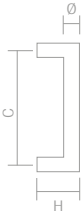

1

Ø	C	H
15	200	55
20	250	65
20	300	65
30	300	90
30	350	90
30	600	90

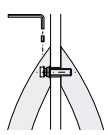

Fijación Doble

41.5530.6
P 41.5531.0
P 41.5532.1
P 41.5533.2
P 41.5534.3
P 41.5535.4

Kit de fijación doble incluido

i-4400

Juego de 2 manillones
Acero Inoxidable

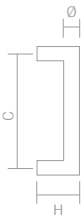

1

Ø	C	H
15	150	55
15	200	55
15	300	55
20	200	65
20	250	65
20	300	65
30	250	90
30	300	90
30	350	90
30	600	90

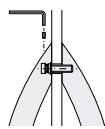

Fijación Doble

P 41.5557.5
41.5558.6
P 41.5559.0
P 41.5560.1
P 41.5561.2
41.5562.3
P 41.5563.4
P 41.5564.5
41.5565.6
41.5566.0

Kit de fijación doble incluido

i-3310

Manillón suelto
Acero Inoxidable



1

Ø	C	H
15	200	55
20	250	65
20	300	65
30	300	90
30	350	90
30	600	90

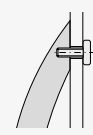

Fijación Simple Vista

41.5536.5
P 41.5537.6
P 41.5538.0
P 41.5539.1
P 41.5540.2
P 41.5541.3

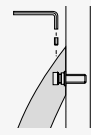

Fijación Simple Oculta

41.5542.4
P 41.5543.5
P 41.5544.6
P 41.5545.0
P 41.5546.1
P 41.5547.2

Kit de fijación simple Vista u Oculta incluido

i-4400

Manillón suelto
Acero Inoxidable

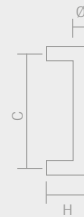

1

Ø	C	H
15	150	55
15	200	55
15	300	55
20	200	65
20	250	65
20	300	65
30	250	90
30	300	90
30	350	90
30	600	90
30	1200	90
30	1500	90
30	1800	90
30	2000	90
30	2200	90

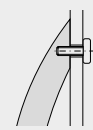

Fijación Simple Vista

P 41.5567.1
41.5568.2
P 41.5569.3
P 41.5570.4
P 41.5571.5
41.5572.6
P 41.5573.0
P 41.5574.1
41.5575.2
41.5576.3
P 41.0198.0
P 41.0199.1
P 41.0200.2
P 41.0201.3
P 41.0202.4

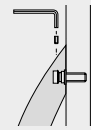

Fijación Simple Oculta

P 41.5577.4
41.5578.5
P 41.5579.6
P 41.5580.0
P 41.5581.1
41.5582.2
P 41.5583.3
P 41.5584.4
41.5585.5
41.5586.6

Kit de fijación simple Vista u Oculta incluido

i-1000

Juego de 2 manillones
Acero Inoxidable

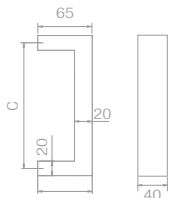

1
C
200
300
500

Kit de fijación doble incluido

i-1000

Manillón suelto
Acero Inoxidable

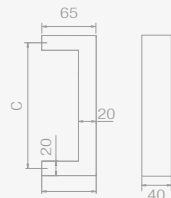

1
C
200
300
500

Kit de fijación simple Vista u Oculta incluido

i-4000

Juego de 2 manillones
Acero Inoxidable

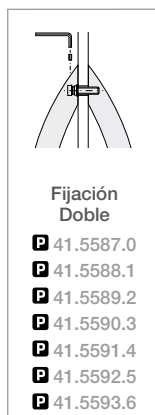

1
Ø C L H
20 200 300 65
20 250 400 65
20 300 450 65
30 300 600 90
30 350 650 90
30 500 800 90
30 600 900 90

Kit de fijación doble incluido

i-4000

Manillón suelto
Acero Inoxidable

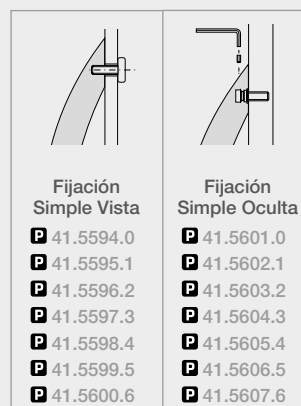

1
Ø C L H
20 200 300 65
20 250 400 65
20 300 450 65
30 300 600 90
30 350 650 90
30 500 800 90
30 600 900 90

Kit de fijación simple Vista u Oculta incluido

i-2700 INCLINADO 65°

Juego de 2 manillones
Acero Inoxidable

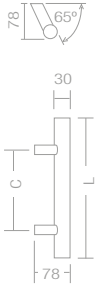

1	
C	L
250	550
300	600

Kit de fijación doble incluido

i-2700 INCLINADO 65°

Manillón suelto
Acero Inoxidable

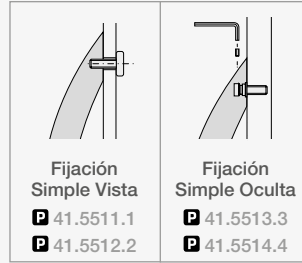

1	
C	L
250	550
300	600

Kit de fijación simple Vista u Oculta incluido

QUIRÓN PLUS

by Selec D&D
Acero Inox AISI 304

SELEC®
Luxury Lever Handle



1/2	200 mm	Cromo Mate	41.4077.2	1/2	200 mm	Cromo Mate	41.4079.4
	250 mm		41.4078.3		300 mm		41.4080.5

MIKONOS

By Selec
Acero Inoxidable

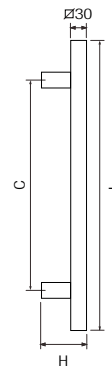

1				Simple	Doble
C	L	H	Acabado	41.0035.2	41.0034.1
400	550	75	Negro Mate		
400	550	75	Blanco Mate	N 41.6785.6	N 41.6786.7

Línea CORREDERAS Manillones y Asas

HERA

Juego 2 asas sin roseta
 Ø20 mm
 Acero Inox AISI 304





 1 
 41.2999.2 Inox Mate

HERA ROSETA

by Selec D&D
 Acero Inox AISI 304



 1/2  
 200 mm 41.2998.1
 250 mm 41.3123.0
 PVD Oro
 Antiguo Mate 41.6731.3

ZEUS PLUS

by Selec D&D
 Acero Inox AISI 304



 1 
 41.4089.0 Inox Mate

HEBE

Juego 2 asas **sin roseta**
 Ø20 mm
 Acero Inox AISI 304



 1 
 41.4019.0 Inox Mate

HEBE ROSETA

by Selec D&D
 Acero Inox AISI 304



 1/2 
 41.4018.6 Inox Mate

ONLY
 Juego 2 asas
sin roseta
 Zamak



1 200
 41.5613.5 Efecto Inox

Incluye Kit de fijación para instalación doble, simple y para instalación en puerta de cristal o madera.

RENTAL
 by Hugo Workshop
 Aluminio - Zamak



1 200
 ① 41.4289.4 Efecto Inox
 ① 41.6631.1 Negro Mate
 ② 41.6014.0 Efecto Inox

①

②

ZK-ZEUS
 By Selec D&D
 Aluminio - Zamak



1 200
 41.4288.3 Efecto Inox

COSTA
 Aluminio

Contiene kit de fijación simple Oculta, y varillas que permiten instalación doble.



1 Cromo Mate
 240 mm 41.4702.4
 480 mm 41.4703.5

128 / 256
 240 / 480

TRI

Sin roseta
Zamak

Permite colocación tanto individual como doble.
Incluye fijaciones.



41.4347.6
41.4349.1
41.4350.2
41.4351.3



Cromo Look
Efecto Inox
Blanco Mate
Negro Mate



ECO-KRISTINA

Sin roseta
Aluminio



41.6630.0
41.6696.3
41.6697.4



Negro Mate
Efecto Inox
Cromo Mate



UNIVERSAL

By DND Technical Division
Latón

dnd

Permite colocación tanto individual como doble. Incluye fijaciones.



41.3353.6 Cromo Mate
41.3350.3 Pulido Brillo
41.5862.2 Cuero Latón Patinado
N 41.0092.4 Antracita



LOG·GIC

By Groë! Studio
Latón



- 41.5840.1 Cromo Mate
- 41.5839.0 Cromo Brillo
- 41.5841.2 Latón Mate
- P** **N** 41.7934.0 Latón Pulido
- P** **N** 41.7931.8 Blanco Mate
- N** 41.7930.7 Negro Mate
- P** **N** 41.7932.9 Grafito



LINEAR

by Mauro Ronchi
Latón

dnd



- P** 41.3415.5 Cromo Mate
- P** 41.5899.4 Cromo Brillo



POD

by Holsher Design
Latón

dnd



Manillón Simple

Manillón Doble



- | | | |
|----------------|--------------------|--------------------|
| Cromo Brillo | P 41.0283.8 | P 41.0289.3 |
| Cromo Mate | P 41.0284.9 | P 41.0290.4 |
| Negro Mate | P 41.0286.0 | P 41.0291.5 |
| PVD Oro Brillo | P 41.0287.1 | P 41.0292.6 |
| PVD Oro Mate | P 41.0288.2 | P 41.0293.7 |



DUAL

Made in Netherlands
Latón / Ébano

Mi Satori



- 42.1174.5 Níquel Brillo
- P** 42.1175.6 Efecto Inox



CHEMIN DE FER

Made in Netherlands
Latón

Mi Satori



- 42.1197.0 Efecto Inox
- 42.1198.1 Negro Mate





dnd

GINKGO BILOBA

by Giulio Iacchetti
Latón



Simple

Doble

PVD Níquel Brillo

P 41.0049.5

P 41.0056.1

P 41.0052.8

P 41.0059.4

PVD Oro Antiguo Brillo

P 41.0050.6

P 41.0057.2

P 41.0053.9

P 41.0060.5

PVD Oro Antiguo Mate

P 41.0051.7

P 41.0058.3

P 41.0055.0

P 41.0061.6

Permite colocación tanto individual como doble.
Incluye fijaciones para vidrio o madera.

dnd

GINKGO

by Giulio Iacchetti
Latón



Simple

Doble

Cromo Mate

P 41.0036.3

P 41.0042.9

P 41.0039.6

P 41.0046.2

PVD Níquel Brillo

P 41.0037.4

P 41.0044.0

P 41.0040.7

P 41.0047.3

PVD Antracita

P 41.0038.5

P 41.0045.1

P 41.0041.8

P 41.0048.4

Permite colocación tanto individual como doble.
Incluye fijaciones para vidrio o madera.



SELEC[®]

Luxury Lever Handle

ICONIC

By Selec
Acero Inoxidable



Doble

Inox Mate

41.0113.3

PVD Oro Mate

41.0114.4

Negro Mate

41.0115.5





Fijación adhesiva para puertas de vidrio



Fijación tornillo pasante para puertas de madera

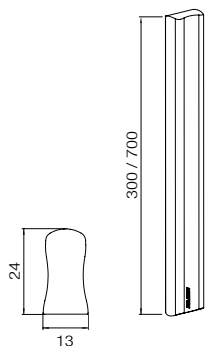

KLEIN®

TEMPO
by Klein
Aluminio



	Alto	Plata Mate	Negro Mate	Bronce Oscuro
Puertas de madera	300	P 39.0083.6	P 39.0085.8	P 39.0088.0
	700	P 39.0084.7	P 39.0086.9	P 39.0089.1
Puertas de vidrio*	300	P 39.0090.2	P 39.0092.4	P 39.0094.6
	700	P 39.0091.3	P 39.0093.5	P 39.0095.7

Se suministran en juego de 2 unidades.
Incluye las fijaciones para vidrio o madera.

Línea CORREDERAS Manillones y Asas



ÁNGOLO
By Groël Studio
Latón

1



Cromo Mate	41.6234.3
Cromo Brillo	41.6235.4
Latón Pulido	41.6236.5
Latón Pulido PVD	P N 41.6750.4
Latón Satinado	P N 41.6747.1
Latón Satinado PVD	P N 41.6751.5
Negro Mate	41.5842.3
Grafito PVD	P N 41.6748.2
Blanco	P 41.5843.4



SKETCH
By Groël Studio
Latón

1



Cromo Mate	P N 41.6542.3	P N 41.6742.7	P 41.5835.3
Cromo Brillo	P N 41.6541.2	P N 41.6743.8	P 41.5834.2
Negro Mate	P N 41.6744.9	P N 41.6746.0	P N 41.6741.6



TORSO
By Groël Studio
Latón

1



Cromo Mate	P 41.5838.6
Cromo Brillo	P 41.5837.5
Latón Pulido	P 41.5836.4
Latón Mate PVD	N P 41.6749.3

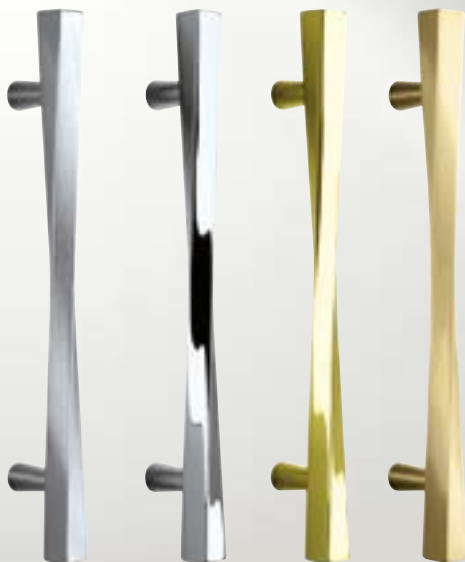

dnd

(IN)FINITO FINE

By Alfonso Femia
Latón



Línea CORREDERAS



Garantía



Cromo Mate 10 **P** 41.0245.3
Negro Mate 5 **P** 41.0246.4
Latón Mate 5 **P** 41.0247.5

Manillones Simples



P 41.0251.9
P 41.0260.7
P 41.0261.8



P 41.0266.2
P 41.0267.3
P 41.0268.4



P 41.0248.6
P 41.0249.7
P 41.0250.8

Manillones Dobles



P 41.0262.9
P 41.0264.0
P 41.0265.1



P 41.0269.5
P 41.0270.6
P 41.0271.7

dnd

LOGO

by Mauro Ronchi
Latón



Cromo Mate 41.3417.0

dnd

FLUKE

by Karim Rashid
Latón



Cromo Mate 41.4257.0
Cromo Brillo **N** 41.5898.3

Línea CORREDERAS Manillones y Asas

VASILISA

Latón



- P** 41.6357.0 Níquel Brillo
- P** 41.6358.1 Latón Pulido

OTTO

Latón



- P** 41.6377.6 Latón Pulido
- P** 41.6378.0 Cromo Brillo
- P** 41.6379.1 Bronce Inglés

dnd

LATINA

DND Technical Division
Latón



- P** 41.5921.5 Cuero Latón Patinado

dnd

LUCREZIA

By Marco Pisati
Latón



- P** 41.6443.2 Latón Pulido
- P** 41.6444.3 PVD Níquel Brillo
- P** 41.6445.4 Cuero Latón Patinado

BONTON

Made in Netherlands
Latón / Ébano

Mi Satori



42.1213.2 Níquel Brillo / Ébano

42.1214.3 Latón Brillo / Ébano

KILTO

By Groël Lab
Latón



41.5814.3 Brunito

41.5815.4 Plata Envejecida

41.0203.5 Bronce Envejecido

LA BISBAL

By Work Studio
Zamak - Porcelana



41.5642.6 Bronce Antiguo / Craquele Beige

41.5646.3 Plata antigua / Craquele Blanco

Mi Satori

TON

Made in Netherlands
Latón / Teka



42.1221.3 Negro Mate / Teka



GINO
By Work Studio
Zamak



41.5631.2
41.5616.1



Cuero Latón Patinado
Latón Brillo Satinado

DANIELA
DND Technical Division
Latón

dnd



41.5906.4
41.5907.5
41.5908.6



Pulido Brillo
Brunito
Bronce Envejecido



ELENA
Tornillo visto
DND Technical Division
Latón

dnd



41.4795.6
41.4794.5
41.4796.0



Cromo Mate
Bronce Envejecido
Efecto Inox

MARÍA
By Groël Lab
Latón



1
41.5824.6 Latón Mate / Brillo
41.5825.0 Cuero Latón Patinado

TAMARA
By Maheval Studio
Latón



1/2
41.5639.3 Brillo Satinado

LORCA
By Work Studio
Zamak



1
41.0205.7 Brillo Satinado
41.6474.5 Cuero Inglés Mate



DONA
Latón



4/20
41.4383.0 Pulido Brillo

RUTE
By Work Studio
Chapa / Zamak



1/4
41.6507.3 Brillo Satinado



ARTITEC

Made in Netherlands

PALANCA EMPUJE PIE

By Artitec Lab.

Acero Inox AISI 304

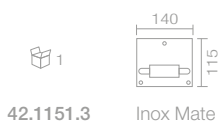

42.1151.3

Inox Mate



HERA PLACA

By Selec D&D

Acero Inox AISI 304



41.3191.5

Inox Mate



41.3192.6

Inox Mate



41.3190.4

Inox Mate

PLACAS BARNIZADAS

Placas decorativas

Latón



34.1285.3
34.2372.5

Latón Mate
Efecto Inox

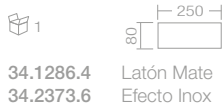

34.1286.4
34.2373.6

Latón Mate
Efecto Inox

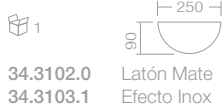

34.3102.0
34.3103.1

Latón Mate
Efecto Inox

Medidas especiales por encargo (10 unidades mínimo)



HERRAJES

Línea HERRAJES Placas para montar manillas

PLACAS PARA MONTAR MANILLAS

Rectangular 245 x 45 mm
Latón

dnd

Importante

Placa adecuada para montar todas las rosetas que no disponen de la misma referencia con placa larga. No precisa de unión entre placa y manilla, gracias al sistema de muelle que incorpora.

Los códigos incluyen placa y muelle metálico independiente.



- 41.4051.4 Cromo Mate
- 41.4052.5 Latón Mate
- 41.4053.6 Cromo Brillo
- 41.3222.1 Latón Pulido
- 41.6477.1 PVD Antracita
- 41.6482.6 Negro Mate



Ejemplos de montaje en combinación con modelos de manillas



Sistema de muelle metálico independiente.



Cuadradillo recomendado



Especialmente indicado para el montaje en puertas de entrada con manetas de roseta. El cuadradillo se expande apretando la tuerca, y vuelve a su posición original aflojándola.



- 34.2439.2 Cuadradillo expansivo 8x65 mm
- 34.4261.7 Cuadradillo expansivo 8x80 mm

ACCESORIO CONVERSION MODELO VIS FINE

Roseta de mínimo espesor
Latón



Convierta su maneta VIS al nuevo sistema FINE de DND Technical Division. Sustituya su roseta y reduzca su ancho a 4 mm para un acabado más minimalista.

- 41.5958.0 Cromo Mate Redondo
- 41.5959.1 Cromo Brillo Redondo
- 41.5956.5 Cromo Mate Cuadrado
- 41.5957.6 Cromo Brillo Cuadrado

PLACAS PARA MONTAR MANILLAS

Acero Inoxidable

Importante

Modelo adecuado para montar con todas las rosetas que no disponen de la misma referencia con placa larga.



- 41.3914.0 Inox Mate



PLACAS PARA MONTAR MANILLAS

Latón

Importante

Modelo adecuado para montar con todas las rosetas que no disponen de la misma referencia con placa larga.

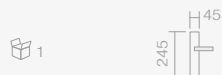

- 41.6549.3 Cromo Mate
- 41.6550.4 Negro Mate
- 41.6955.0 Blanco Mate



groël
handle design

TESA 3500

Roseta Ø65

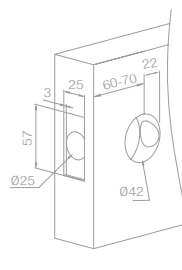
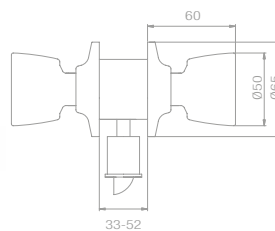

Puertas de paso	
Condena	
Llave y condena	
Solo llave	
Portero electrónico	
Cuadrillo: Pomo tirador	

Nuevo sistema de picaporte ajustable a 60 y 70 mm de aguja

1/20 Tipo cuadradillo	Ref. TESA	Latón Mate 60/70 mm	Cromo Mate 60/70 mm
Puertas de paso	3505	34.3084.3	34.3087.6
Condena: baños/dormitorios	3503	34.3085.4	34.3088.0
Llave y condena: puertas de entrada	3500	34.3086.5	34.3089.1
Solo llave: puertas a condonar	3501	P 34.2949.1	P 34.2951.3
Solo llave: puertas tipo portería sin condonar	3502	P 34.2950.2	P 34.2952.4

Sistema Cuadradillo



1/20 Tipo cuadradillo	Ref. TESA	Latón Mate	Cromo Mate	Pulido Brillo	Cromo Brillo
Picaporte suelto 70/60 mm	PO30			34.2961.6	34.2962.0
Cuadradillo Ø8 mm.	3534	34.0398.5	34.0411.4		
Pomo tirador fijo	3531	34.0397.4	34.0410.3		
Portero electrónico de 50 mm	3520	34.0396.3	34.0409.2		

Placas decorativas Latón Mate

1/10

- P** 34.0425.4 Rectangular
- P** 34.0424.3 Cuadrada

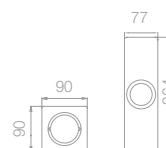

ACCES MIRA

Roseta Ø50

By Ricado Bofill - Marta Vilallonga



1/20

Puerta de paso

Ref. TESA	Efecto Inox 60/70 mm
3M05R-60/70	34.3105.3

Línea HERRAJES Manetas tipo pomo



TESA 3900 Roseta Ø65

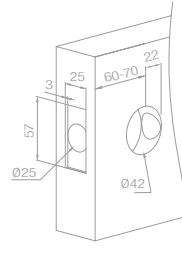
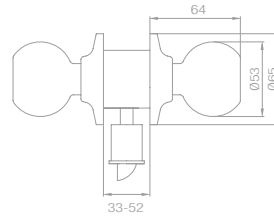

Puertas de paso	
Condena	
Llave y condena	
Solo llave	
Portero electrónico	
Cuadradillo: Pomo tirador	

1/20 Tipo cuadradillo	Ref. TESA	Latón Pulido 60/70 mm	Cromo Brillo 60/70 mm	Cromo Mate 60/70 mm	Negro Mate 60/70 mm
Puertas de paso	3905	34.3090.2	34.3093.5	34.3096.1	34.3099.4
Condena: baños/dormitorios	3903	34.3091.3	34.3094.6	34.3097.2	34.3100.5
Llave y condena: puertas de entrada	3900	34.3092.4	34.3095.0	34.3098.3	34.3101.6
Solo llave: puertas a condonar	3901	P 34.2953.5		34.2956.1	P 34.2957.2
Solo llave: puertas tipo portería sin condonar*	3902	34.2954.6	P 34.2959.4	34.2958.3	P 34.2960.5

1/20 Tipo cuadradillo	Ref. TESA	Cromo Mate	Pulido Brillo	Cromo Brillo	Negro Mate
Picaporte suelto 60/70 mm	PO30		34.2961.6	34.2962.0	
Cuadradillo Ø8 mm.	3934	34.1575.6	34.0483.6		34.1738.1
Pomo tirador fijo	3931	34.1593.3	34.0482.5		

Sistema Cuadradillo



ALICANTE

Especial para tapar pomo americano Zamak



1	
41.6494.4	Pulido Brillo
41.6495.5	Efecto Inox



TESA 3B
Roseta Ø65

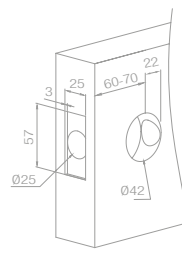
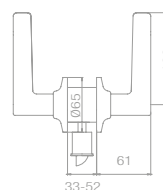

Nuevo sistema de picaporte ajustable a 60 y 70 mm de aguja

1/20 Tipo cuadradillo	Ref. TESA	Cromo Mate	Pulido Brillo	Cromo Mate	Pulido Brillo	Cromo Brillo
		60/70 mm	60/70 mm			
Puertas de paso	3B05	34.2943.2	34.2944.3			
Condena: baños/dormitorios	3B03	34.2945.4	34.2946.5			
Llave y condena: puertas de entrada	3B00	34.2947.6	34.2948.0			
1/20 Tipo cuadradillo	Ref. TESA	Pulido Brillo	Cromo Mate	Cromo Brillo		
Picaporte suelto 70/60 mm	PO30	34.2961.6		34.2962.0		
Cuadradillo 8 mm. Derecha	3B34	34.1517.4	34.2096.2			
Cuadradillo 8 mm. Izquierda	3B34	34.1530.3	34.2097.3			

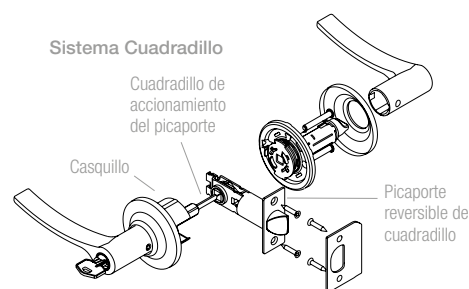

SANTORINI
Roseta Ø65
Zamak



1	Ø65	Cromo Mate	Negro Mate
41.0103.4			
41.0102.3			

POMO GIRATORIO CON PLACA

Sin muelle
Latón



1/16



41.6648.4
41.6649.5

Efecto Inox
Brillo Satinado



i-1260

Juego 2 pomos fijos
o giratorios
Acero Inoxidable

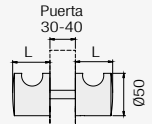

Incluye Kit de fijación

1	L
P 41.4806.3	44 Fijo
P 41.4807.4	48 Giratorio

DUTY

Juego 2 pomos
giratorios con muelle
Latón

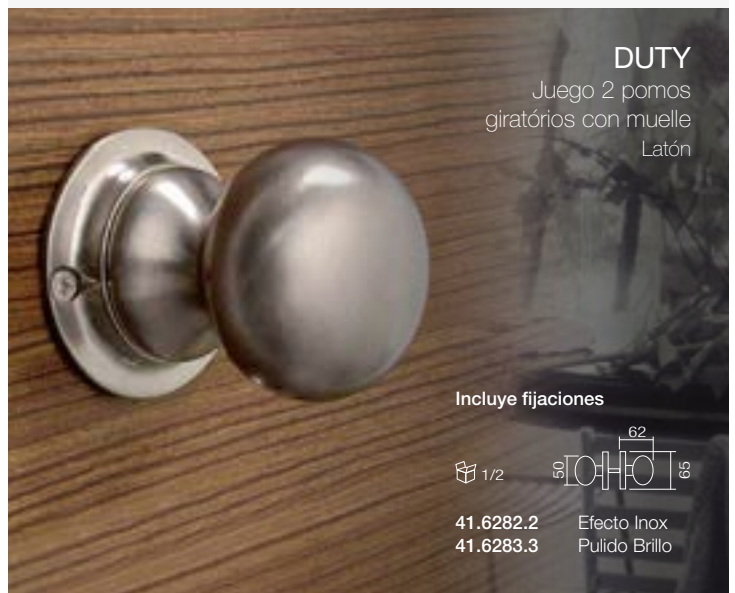

Incluye fijaciones

1/2



41.6282.2 Efecto Inox
41.6283.3 Pulido Brillo

IGNÍFUGA

Resistente al fuego
Acero



1



41.2598.0

Rilsan Negro



ROMÁN

Resistente al fuego
Aluminio



No incluye bocallave

1



41.4236.0
41.4237.1

Blanco
Negro



QUATTRO 02-Z
By DND Technical Division
Zamak

dnd

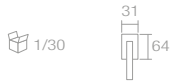

41.5869.2 Cromo Mate
41.5870.3 Cromo Brillo

HANDY
By Mauro Ronchi
Latón

dnd

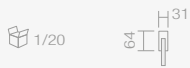

41.4706.1 Cromo Mate
41.4707.2 Pulido Brillo

LUCE
By DND Technical Division
Zamak

dnd

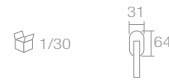

41.5863.3 Cromo Mate
41.5864.4 Cromo Brillo
41.5866.6 Cuero Latón Patinado
41.6450.2 Negro Mate

PISA
By Work Studio
Zamak

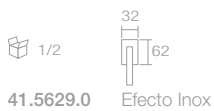

41.5629.0 Efecto Inox

HERA
By Selec D&D
Acero Inox AISI 304



41.3243.1 Inox Mate

CLAUDIO
Aluminio

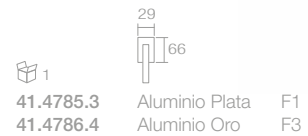

41.4785.3 Aluminio Plata F1
41.4786.4 Aluminio Oro F3

PISA
By Work Studio
Zamak



41.5630.1 Latón Brillo Satinado

ALBIN
By Work Studio
Zamak

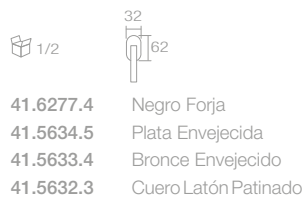

41.6277.4 Negro Forja
41.5634.5 Plata Envejecida
41.5633.4 Bronce Envejecido
41.5632.3 Cuero Latón Patinado

LA BISBAL
By Work Studio
Zamak / Porcelana

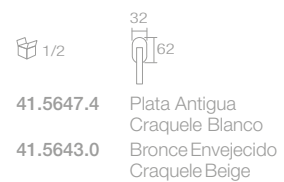

41.5647.4 Plata Antigua Craquele Blanco
41.5643.0 Bronce Envejecido Craquele Beige

Línea HERRAJES

GRAF

Tope Ø27 mm

Fijación tornillo

Aluminio



1/12

- N** 08.3411.5 Efecto Inox
- N** 08.3412.6 Negro Cepillado
- N** 08.3410.4 Latón Cepillado



ARPA

Tope Ø45 mm.

Fijación tornillo / Adhesivo

Aluminio



1/12

- N** 08.3403.8 Efecto Inox
- N** 08.3402.7 Negro Cepillado
- N** 08.3401.6 Latón Oxidado
- N** 08.3448.9 Latón Mate



PUK WOOD Tope de grandes dimensiones

Tope Ø65 mm.

Adhesivo

Madera

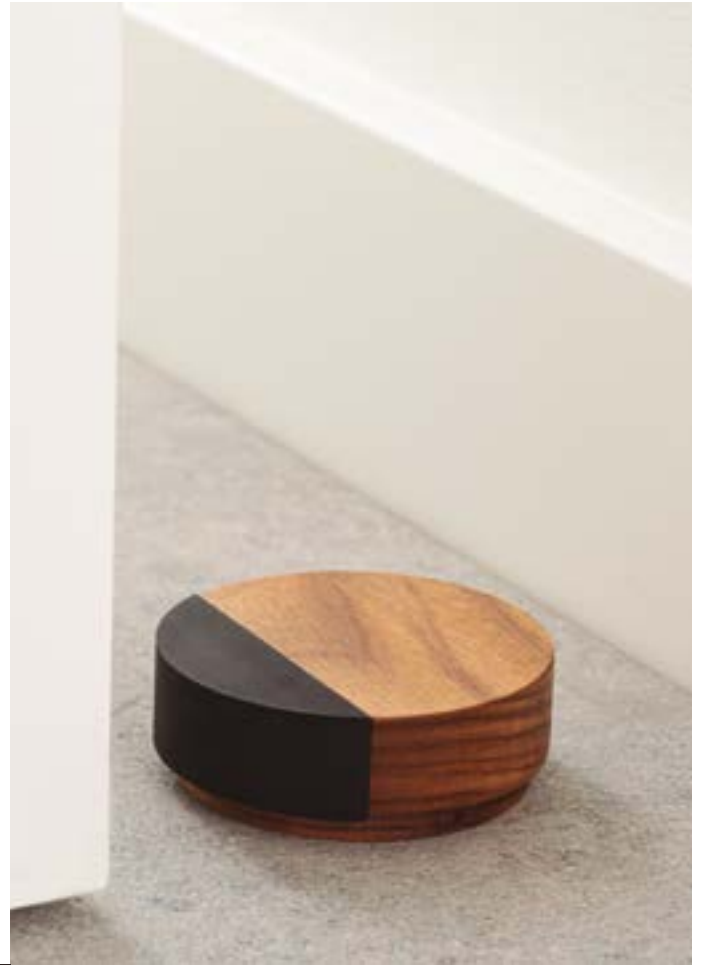

1/12

- N** 08.3404.9 Roble
- N** 08.3406.0 Nogal
- P N** 08.3407.1 Fresno Negro



LOW

Tope Ø48 mm

Fijación tornillo / Adhesivo

Aluminio



1/12

- N** 08.3408.2 Latón Cepillado
- N** 08.3409.3 Antracita



TIMOTEU / TELMO

Tope Ø25 mm.
Fijación **tornillo**
Latón / Acero Inoxidable



1/50

- 08.3416.0 Negro Mate
- 08.3375.2 Blanco Mate
- 08.3322.5 Pulido Brillo
- 08.3321.4 Latón Cuero Patinado
- N** 08.3415.9 Inox Mate



BOSTON

Tope Ø28 mm.
Fijación **tornillo con base**
Zamak



1/40

08.3320.3 Efecto Inox

LOUISE

Tope Ø36 mm.
Adhesivo **extrafuerte**
Acero Inoxidable



1/8

N 08.0091.3 Acero Inox



SANSÓN

Tope Ø30 mm.
Fijación **tornillo**
Acero Inoxidable

SELEC®
Lever Handle



1

08.2237.5 Inox Mate

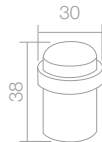

ADAN

Tope Ø36 mm.
Fijación **tornillo**
Acero Inox AISI 304

SELEC®
Lever Handle



1/50

- N** 08.3393.9 Inox Mate
- N** 08.3395.0 Negro Mate

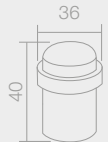

ANSU

Tope Ø20 mm.
Fijación **tornillo**
Acero Inoxidable

En negro industrial, ideal para los modelos de manillas Boho / Irontech



1/25

N 41.6994.6 Negro industrial

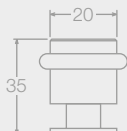

FATI

Tope ∇ 20 mm.
Fijación **tornillo**
Acero Inoxidable

En negro industrial, ideal para los modelos de manillas Boho / Irontech



1/25

- N** 41.6995.7 Negro Industrial
- N** 41.6997.9 Inox Mate

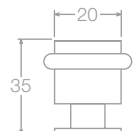

DADO
Tope Ø20 mm.
Latón

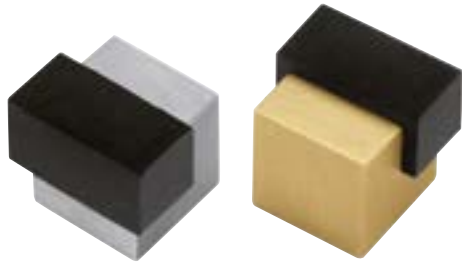

1/10

- 41.5857.4 Cromo Mate
- 41.5856.3 Cromo Brillo
- P** 41.5855.2 Latón Mate
- P** 41.5854.1 Pulido Brillo

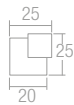

CUBE
Tope Ø30 mm.
Latón



1/10

- P** 41.5859.6 Cromo Mate
- P** 41.5858.5 Cromo Brillo
- P** 41.5860.0 Negro
- P** 41.5861.1 Blanco

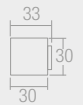

LUX
Tope Ø45 mm.
Fijación **tornillo**
Zamak / Acero Inox



1/25

- 08.0306.6 Cromo Mate Goma Blanca
- N** 08.3420.3 Inox Mate Goma Negra



FRANZ
Tope Ø47 mm.
Adhesivo **con espuma**
ABS



1/40

- 08.2231.6 Cromo Mate



ALLAN
Tope Ø52 mm.
Adhesivo **con imán**
Plástico



1/20

- 08.2232.0 Cromo Mate
- 08.0092.4 Blanco

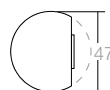

OTTO

Tope Ø48 mm.
Adhesivo **con imán**
Madera

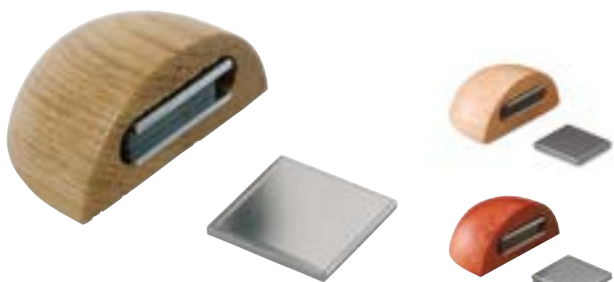

1/20

- 08.2247.1 Roble
- 08.0096.8 Sapelly
- 08.0097.9 Haya

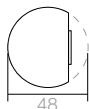

EDDY

Tope Ø48 mm.
Adhesivo
Madera



1/20

- 08.2248.2 Roble
- 08.2249.3 Sapelly
- 08.0084.7 Haya

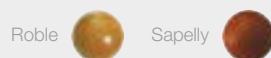

IAN

Tope Ø40 mm.
Adhesivo
Madera



1/20

- 08.2233.1 Haya
- N** 08.3413.7 Roble
- N** 08.3414.8 Sapelly



ADRIAN

Tope Ø46 mm.
Adhesivo **extrafuerte**
Madera



1/10

- N** 08.0088.0 Roble
- N** 08.0086.9 Sapelly
- N** 08.0089.1 Haya



ALBERTO

Tope Ø46 mm.
Adhesivo
Madera



1/10

- 08.0113.3 Olivo mediterráneo
- 08.0114.4 Arce Nórdico
- 08.0115.5 Fresno Calcáreo
- 08.0116.6 Nogal Americano
- 08.0117.7 Wengué Africano



NEW MIKE

Tope Ø45 mm.
Adhesivo transparente
Resina / Poliuretano



Permite pasar inadvertido con cualquier tipo de suelo.

1/25

N 08.3418.1 Transparente



CASPER

Jgo. de 2 Topes Ø40 mm.
Adhesivo transparente
Poliuretano



1/10

08.0083.6 Transparente
08.0112.2 Blanco

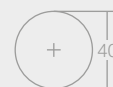

GASPAR

Tope Ø52 mm.
Adhesivo transparente **extrafuerte**
Resina / Poliuretano



Permite pasar inadvertido con cualquier tipo de suelo.

1/10

08.0085.8 Transparente

LILIAN

Tope Ø46 mm. Ø30 mm.
Adhesivo transparente **extrafuerte**
Resina / Poliuretano



1.



2.

		Transparente	Medidas
1	1/10	08.0090.2	46x18 mm.
2	1/25	N 08.3419.2	30x30 mm.

MIRKO

Tope retenedor
Adhesivo transparente
Poliuretano



Permite pasar inadvertido con cualquier tipo de suelo.

1/10

08.0095.7 Transparente

LANCE

Jgo. de 2 Topes de pared Ø35 mm.
Adhesivo
Poliuretano / Goma



1/10

08.0099.0 Blanco

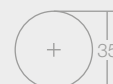

ARPA WALL

Tope para pared Ø50 mm.
Fijación tornillo / Adhesivo
Aluminio



1/12

- N** 08.3399.4 Efecto Inox
- N** 08.3400.5 Negro Cepillado
- N** 08.3398.3 Latón Oxidado
- N** 08.3450.0 Latón Mate

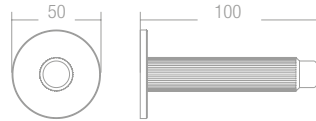

Se instala en la pared en el área donde la puerta hace contacto, proporcionando una estética elegante y resistente a los impactos.

TURIN

Tope para pared **tornillo**
Largo 80 mm
Acero Inoxidable



1/10

08.3330.6 Inox Mate



OVNI

Tope retenedor sobrepuesto Fine
Ø65 mm.
Zamak

SELEC®
Lever Handle

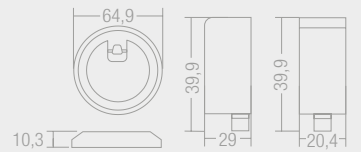

Revolucionario sistema de tope de puerta ultrafino con freno y retenedor mecánico que requerirá un movimiento hacia dentro para liberar el retenedor y permitir cerrar la puerta.

1/10

- N** 08.3396.1 Efecto Inox
- N** 08.3397.2 Negro Mate



ANDREW

Tope para pared **tornillo**
Largo 85 mm
Madera



1/10

- 08.0100.1 Sapelly
- 08.0101.2 Haya



LUIGI

Tope retenedor Ø40 mm.
Adhesivo transparente
Poliuretano



1/10

08.0093.5 Transparente
08.0094.6 Blanco

ESAU

Tope retenedor bajo puerta
Fijación tornillo
Latón / Zamak



1/25

08.2129.2 Cromo Brillo
08.0111.1 Efecto Inox

FRENO RETENEDOR

A suelo de 125 x 30 mm
Latón



1/10

08.0453.6 Bronce

130
30

HIKARI

Tope y retenedor magnético oculto para puertas.



Tope de puerta que reúne dos funciones en un sólo producto; tope y retenedor. Con un imán de neodimio de alta potencia, cuando la puerta pasa por encima queda fijada y retenida. Un sistema imperceptible integrado en la puerta y el suelo.



Tope Ikari embutido

Instalación

1/20

Tope embutido 08.3364.5 Transparente

1/20 **Tope sobreponer** 08.0104.5 Niquelado



ESCOLAR

Acero

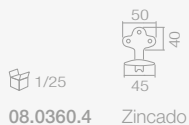

08.0360.4 Zincado

DECO

Acero Inoxidable



61.0103.3 Inox Mate
61.0000.0 Negro Mate

ADRIEL

Acero Inoxidable



41.4243.0 Inox Mate
41.6992.4 **N** Negro Mate

CITY

Zamak



08.3280.5 Cromo Mate
08.3281.6 Cromo Brillo

VENUS

Acero Inox Austenítico

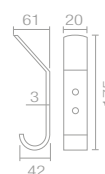
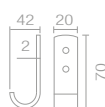

41.4373.4 Inox Mate



41.4372.3 Inox Mate

TUDOR

Zamak



08.3282.0 Cromo Mate

JANE

Zamak

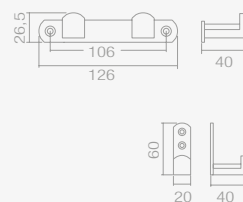

- 08.3341.3 Efecto Inox Mate "Simple"
- 08.3342.4 Efecto Inox Mate "Doble"

CLAUS

Zamak

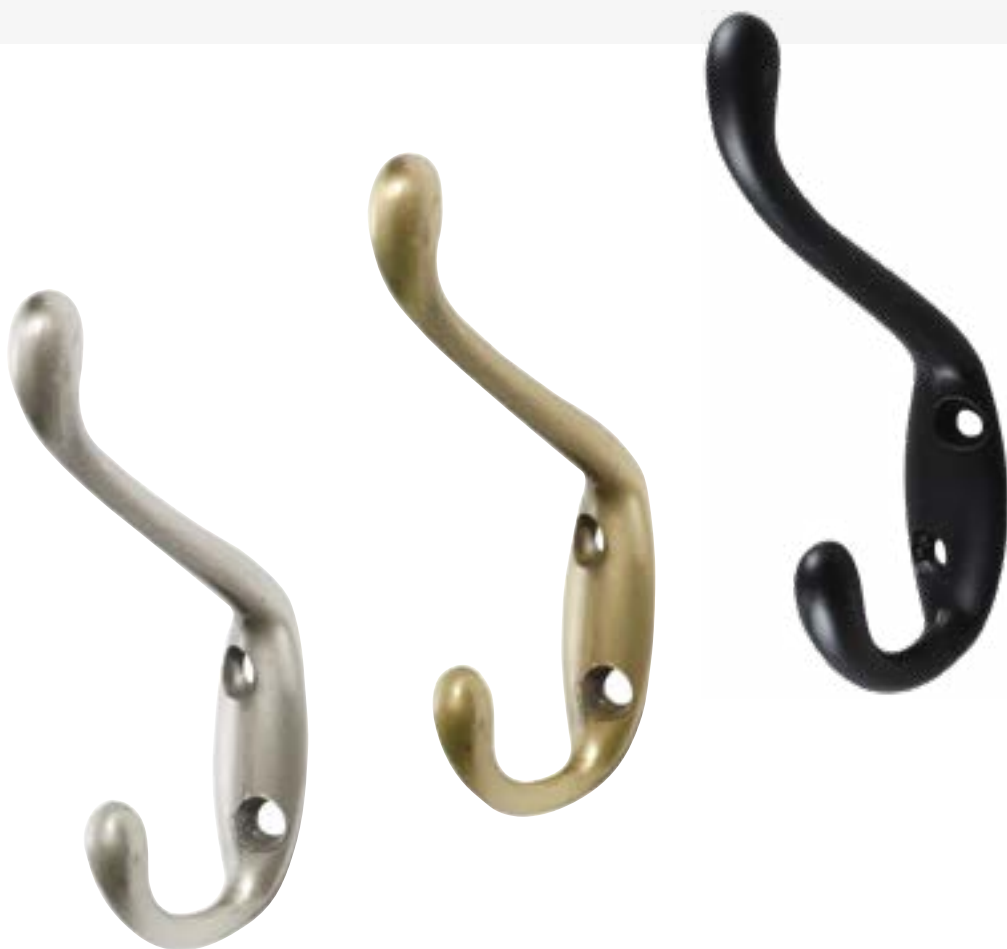

- 41.4755.1 Efecto Inox
- 41.4756.2 Cuero Latón Patinado
- 41.6281.1 Negro Mate

CLAU

Aluminio



- N** 40.0520.3 Niquel Brillo
- N** 40.0521.4 Negro Mate

GANCHO

Latón





- 08.2042.6 Oro
- 08.2043.0 Mercurio
- 08.2045.2 Negro Mate

PIN HANG

Acero / Aluminio

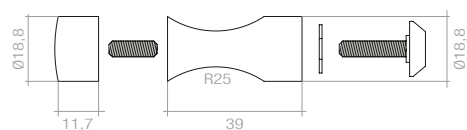
Sistema versátil e innovador de cartela que permite un perfil embutido a madera o visto. El set de tornillería específica de aluminio en el acabado del perfil (15 tornillos métricos por perfil) incluye las fijaciones para instalarlo directamente a pared o para montar una madera sobrepuesta. Instalación del perfil sobrepuesto a pared.



		Titanio		Aluminio
Perfil 3 m.	1/16	01.0005.5	16	P 01.0001.1
Soporte colgador (Ud.)	1/12	01.0194.7	12	P 01.0195.8
Tornillería Madera / Pared	15/240	01.0011.0	240	P 01.0009.9



Especificaciones técnicas:

Capacidad máxima de 10 Kg. Perfil longitud de 3 m.
Los perfiles pueden estar a la vista o encajados en paneles mecanizados.

Instalación del perfil embutido en madera. En la fase de fresado de los paneles, dejar 100 mm. desde arriba y desde abajo del panel.





FLOID
Zamak



1/12

- 41.0168.3 Oro Cepillado
- 41.0169.4 Plata Vieja
- 41.0170.5 Latón Antiguo
- 41.0171.6 Blanco Mate
- 41.0172.7 Negro Mate

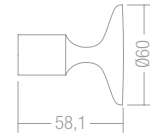

GRAF
Aluminio



1/12

- 41.0173.8 Efecto Inox Cepillado
- 41.0174.9 Latón Cepillado
- 41.0178.2 Negro Cepillado

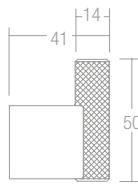

ARPA
Aluminio



1/12

- N** 41.6986.9 Efecto Inox
- N** 41.6988.0 Negro Cepillado
- N** 41.6989.1 Latón Oxidado
- N** 41.7907.6 Latón Mate

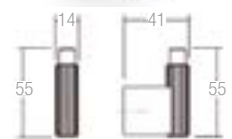

ZOOT

Aluminio / Madera



Ø	L	1/12	Latón / Nogal	Negro / Roble
60	64,5	1/12	41.0161.7	41.0162.8
90	67,0	1/12	41.0163.9	41.0165.0
120	69,5	1/6	41.0166.1	41.0167.2

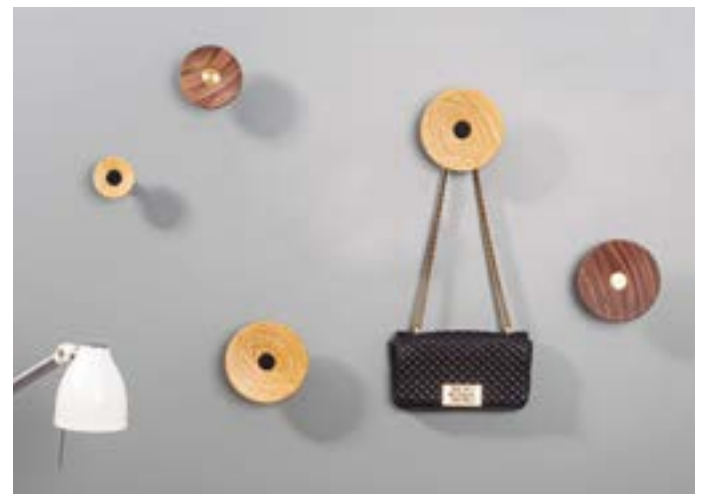

TIK

Fijación con adhesivo
Aluminio

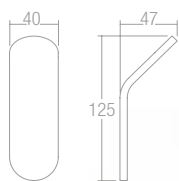

1/6

- N** 41.6768.0 Amarillo Mate
- N** 41.6769.1 Azul Turquesa
- N** 41.6770.2 Blanco Mate
- N** 41.6771.3 Gris Musgo
- N** 41.6772.4 Negro Mate
- N** 41.6773.5 Rosa Mate

LUV

Zamak

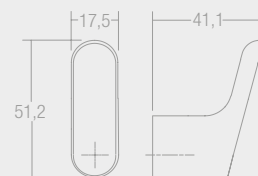

1/12

- N** 41.7913.1 Efecto Inox Mate
- N** 41.7914.2 Latón Cepillado
- N** 41.7915.3 Blanco Mate
- N** 41.7916.4 Negro Mate

DIABOLO

Aluminio



1/12

- N** 41.6761.4 Gris Cepillado
- N** 41.6762.5 Efecto Inox Mate
- N** 41.6763.6 Latón Oscuro Cepillado
- N** 41.6764.7 Negro Cepillado



ORBIT

Zamak



1/6

- N** 41.6765.8 Cobre
- N** 41.6766.9 Oro

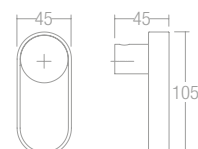

GIRO

Percha giratoria 180°
Acero Inoxidable 304

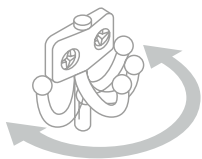

Gancho giratorio 180°
protegido mediante punta
esférica y con sistema
de seguridad anti cierre
accidental.

1/100

N 41.7908.7 Inox Mate

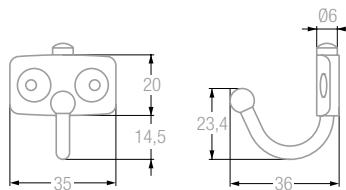

HOOK

Percha fijación a techo
Acero Inoxidable 304



1/40

N 41.7909.8 Inox Mate

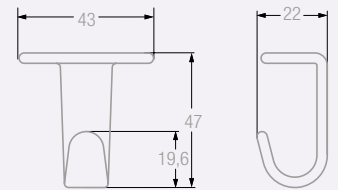

RETRAC

Percha con cierre automático **para embutir**
Aluminio



1

N 41.7918.6 Antracita

N 41.7919.7 Cromo Mate

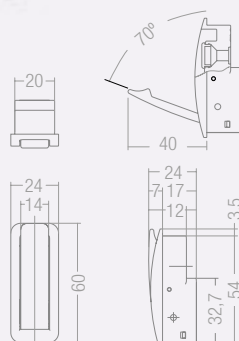

Línea HERRAJES Bocallaves Cuadrados y Decorativos

Nº	Serreta	Borjas	Medidas	Espesor	Acabado	Material	
1	41.4090.1	41.4091.2	52x52	10 mm.	Inox Mate	Inox	1/20
2	41.4505.3	41.4503.1	50x50	7 mm.	Cromo Mate	Latón	1/30
2	41.4504.2	41.4502.0	50x50	7 mm.	Cromo Brillo	Latón	1/30
2	41.5950.6	P 41.5951.0	50x50	7 mm.	Pulido Brillo	Latón	1/10
2	41.5952.1	41.5953.2	50x50	7 mm.	Blanco Mate	Latón	1/10
2	41.5954.3	41.5955.4	50x50	7 mm.	Negro Mate	Latón	1/10
3	41.6732.4		50x50	10 mm.	Efecto Inox	Zamak	1/10
3	41.6596.1		50x50	10 mm.	Cromo Mate	Zamak	1/20
4	41.5946.2	41.5947.3	50x50	4 mm.	Cromo Mate	Latón	1/10
4	41.5948.4	41.5949.5	50x50	4 mm.	Cromo Brillo	Latón	1/10
4	41.6245.0	P 41.6246.1	50x50	4 mm.	PVD Antracita	Latón	1/10
4	N 41.7927.4	P N 41.7928.5	50x50	4 mm.	Negro Mate	Latón	1/10



BOHO

Hierro Industrial



42.1117.4



Negro industrial



42.1118.5



Negro industrial

DANIELA Oval

60 x 40 mm

Latón



41.2968.6

Borjas
Brunito



41.2969.0

Serreta
Brunito

BOCALLAVE Serreta R/98-B

Hierro Forjado



41.5003.4

Negro

41.5004.5

Anticuario

P 41.5005.6

Plata vieja

ANDRATX

Hierro



41.6304.3



Óxido corten*

* Con barniz de protección antimanchas al contacto

Nº	① Serreta	② Borjas	③ Ciego	④ Diámetro	⑤ Espesor	Acabado	Material	📦
1	41.6599.4			Ø50	10 mm.	Negro Mate	Zamak	1/10
1	P 41.0310.2	P 41.0311.3		Ø50	10 mm.	Antracita	Zamak	1/20
1	41.6598.3			Ø50	10 mm.	Cromo Mate	Zamak	1/20
1	N 41.6983.6			Ø50	10 mm.	Efecto Inox	Zamak	1/20
1	41.6708.1	41.6709.2		Ø50	10 mm.	Blanco Mate	Zamak	1/10
1	41.4649.0			Ø52	10 mm.	Efecto Inox	Zamak	1/20
1	41.4650.1			Ø52	10 mm.	Latón Mate	Zamak	1/20
2	P 41.6721.0	P 41.6724.3		Ø50	7 mm.	PVD Oro Antiguo Brillo	Latón	1/30
2		41.2948.0		Ø50	7 mm.	Oro 24 k	Latón	1/30
2	41.4497.2	41.4496.1		Ø50	7 mm.	Pulido Brillo	Latón	1/30
2	41.4498.3	41.4499.4		Ø50	7 mm.	Cromo Brillo	Latón	1/30
2	41.4500.5	41.4501.6		Ø50	7 mm.	Cromo Mate	Latón	1/30
2	41.4480.6	41.4481.0		Ø50	7 mm.	Efecto Inox	Latón	1/30
2	41.4485.4	41.4484.3		Ø50	7 mm.	Latón Mate	Latón	1/30
2	41.5940.3	41.5941.4		Ø50	7 mm.	Brunito	Latón	1/30
2	41.6243.5	P 41.6244.6		Ø50	7 mm.	PVD Antracita	Latón	1/30
2	41.6250.5	41.6251.6		Ø50	7 mm.	Negro Mate	Latón	1/30
2	P 41.6719.5	P 41.6722.1		Ø50	7 mm.	Verde	Latón	1/30
2	P 41.6720.6	P 41.6723.2		Ø50	7 mm.	Níquel Brillo	Latón	1/30
2	P 41.6721.0	P 41.6724.3		Ø50	7 mm.	PVD Oro Antiguo Brillo	Latón	1/30
2		41.2948.0		Ø50	7 mm.	Oro 24 k	Latón	1/30
2	N 41.0310.2	N 41.0311.3		Ø50	4 mm.	Antracita	Latón	1/30
3	41.6470.1	41.6469.0		Ø50	4 mm.	Negro Mate	Aluminio	1/2
3	N 41.0229.9	N 41.0231.0		Ø50	4 mm.	Negro Mate FINE	Latón	1/30
3	N 41.0306.9	N 41.0305.8		Ø50	4 mm.	Cuero Latón Patinado FINE	Latón	1/30
3	41.6003.3	41.6004.4		Ø50	4 mm.	Cromo Brillo	Latón	1/30
3	41.6001.1	41.6002.2		Ø50	4 mm.	Cromo Mate	Latón	1/30
3	41.6684.5	P 41.6685.6		Ø50	4 mm.	PVD Antracita	Latón	1/2
3	41.6686.0	P 41.6687.1		Ø50	4 mm.	Níquel Brillo	Latón	1/2
3	P 41.6688.2	P 41.6689.3		Ø50	4 mm.	PVD Oro Antiguo Brillo	Latón	1/2
3	41.6690.4	P 41.6691.5		Ø50	4 mm.	PVD Oro Antiguo Mate	Latón	1/2
3	P 41.6692.6	P 41.6693.0		Ø50	4 mm.	PVD Cobre Mate	Latón	1/2
3	41.0008.8	41.0011.0		Ø52	5 mm.	Efecto Inox Mate	Zamak	1/12
3	41.0009.9	41.0012.1		Ø52	5 mm.	Negro Mate	Zamak	1/12
3	N 41.0024.2	N 41.0023.1	N 41.0033.0	Ø52	5 mm.	Negro Mate	Inox	1/12
3	N 41.6787.8	N 41.6788.9		Ø52	5 mm.	Blanco Mate	Inox	1/12
3	N 41.6760.3	N 41.6791.1		Ø52	5 mm.	Cromo Mate	Inox	1/12
4	N 41.0110.0			Ø54	5 mm.	Inox Mate	Inox	1/20
4	N 41.0111.1			Ø54	5 mm.	PVD Oro Mate	Inox	1/20
4	N 41.0112.2			Ø54	5 mm.	Negro Mate	Inox	1/20
4	41.2989.6	41.2990.0	41.4689.5	Ø54	7 mm.	Inox Mate	Inox	1/20
4	41.6729.1			Ø54	10 mm.	PVD Oro Mate	Inox	1/20
5	41.6280.0			Ø52	10 mm.	Negro Forja	Zamak	1/12
5	41.4757.3			Ø52	10 mm.	Cuero Latón Patinado	Zamak	1/20
5	41.4758.4			Ø52	10 mm.	Bronce Envejecido	Zamak	1/20
5	41.4759.5			Ø52	10 mm.	Plata Envejecida	Zamak	1/20
5	41.5622.0			Ø52	10 mm.	Latón Brillo Satinado	Zamak	1/20



SELENA SEGURIDAD

Serreta y Borjas Ø54 mm
Acero Inoxidable

El bocallave 41.2989.6 está preparado para la fijación de los tornillos que se precisan para la instalación del bocallave de seguridad de la cerradura.

📦 1/10 **Serreta**
41.2989.6 Inox Mate
41.6729.1 PVD Oro Mate

Borjas
41.2990.0 Inox Mate

TOY SEGURIDAD

Serreta Ø52 mm
Acero

Especialmente concebido para la colocación en puertas blindadas. Incluye elemento preparado para la fijación de los tornillos que se precisan para la instalación del bocallave de seguridad de la cerradura.

📦 1/12
41.4085.3 Latón Pulido
41.4086.4 Cromo Mate

TOY VISTO SEGURIDAD

Serreta Ø58 mm. Tornillo visto.
Acero

Especialmente concebido para la colocación en puertas blindadas. Incluye elemento preparado para la fijación de los tornillos que se precisan para la instalación del bocallave de seguridad de la cerradura.

📦 1/20
08.3331.0 Acero Inoxidable

ESTÁNDAR

Nº	Código	Diámetro	Espesor	Acabado	Material	
1	41.3800.5	Ø52	10 mm.	Efecto Inox	Zamak	1/20
1	41.6634.4	Ø50	10 mm.	Negro Mate	Zamak	1/2
2	41.0013.2	Ø52	5 mm.	Efecto Inox Mate	Zamak	1/12
2	41.0014.3	Ø52	5 mm.	Negro Mate	Zamak	1/12
3	N 41.0025.3	Ø52	5 mm.	Negro Mate	Inox	1/10
3	N 41.6792.2	Ø52	5 mm.	Cromo Mate	Inox	1/10
3	N 41.6790.0	Ø52	5 mm.	Blanco Mate	Inox	1/10
4	41.6707.0	Ø50	10 mm.	Blanco Mate	Zamak	1/10
5	41.5778.2	Ø50	7 mm.	Cromo Mate	Latón	1/15
5	41.5777.1	Ø50	7 mm.	Cromo Brillo	Latón	1/15
5	N 41.7910.9	Ø50	7 mm.	Cuero Latón Patinado	Latón	1/15
5	41.6252.0	Ø50	7 mm.	Negro Mate	Latón	1/15
5	P 41.0309.1	Ø50	7 mm.	Antracita	Latón	1/15
6	P 41.6725.4	Ø50	7 mm.	Verde	Latón	1/15
6	P 41.6726.5	Ø50	7 mm.	Níquel Brillo	Latón	1/15
6	P 41.6727.6	Ø50	7 mm.	PVD Oro Antiguo Brillo	Latón	1/15
6	P 41.6241.3	Ø50	7 mm.	PVD Antracita	Latón	1/15
6	41.4475.1	Ø50	7 mm.	Pulido Brillo	Latón	1/15
6	41.4483.2	Ø50	7 mm.	Latón Mate	Latón	1/15
6	41.5932.2	Ø50	7 mm.	Brunito	Latón	1/15
7	41.5999.6	Ø50	4 mm.	Cromo Mate	Latón	1/2
7	41.6000.0	Ø50	4 mm.	Cromo Brillo	Latón	1/2
7	41.6678.6	Ø50	4 mm.	PVD Antracita	Latón	1
7	P 41.6679.0	Ø50	4 mm.	Níquel Brillo	Latón	1
7	N 41.0308.0	Ø50	4 mm.	Cuero Latón Patinado	Latón	1
7	P 41.6680.1	Ø50	4 mm.	Negro Mate	Latón	1
7	P 41.6681.2	Ø50	4 mm.	PVD Oro Antiguo Brillo	Latón	1
7	41.6682.3	Ø50	4 mm.	PVD Oro Antiguo Mate	Latón	1
7	P 41.6683.4	Ø50	4 mm.	PVD Cobre Mate	Latón	1
8	N 41.0116.6	Ø54	5 mm.	Inox Mate	Inox	1/20
8	N 41.0117.7	Ø54	5 mm.	PVD Oro Mate	Inox	1/20
8	N 41.0118.8	Ø54	5 mm.	Negro Mate	Inox	1/20



TÉCNICA



Nº	Código	Diámetro	Acabado	Material	
1	41.6730.2	Ø54	PVD Oro Mate	Inox	1/10
1	41.3124.1	Ø54	Inox Mate	Inox	1/10
2	41.3193.0	Ø54	Inox Mate	Inox	1/10
3	N 90.0000.0	Ø54	Inox Mate	Inox	1/5

MINI



Código	Diámetro	Acabado	Material	
41.3787.6	Ø35	Inox Mate	Inox	1/5
41.4378.2	Ø35	Efecto Inox	Zamak	1/20
41.6645.1	Ø35	Cromo Mate	Zamak	1/5
41.6643.6	Ø35	Pulido Brillo	Zamak	1/5
41.6644.0	Ø35	Latón Mate	Zamak	1/5
41.4763.2	Ø35	Cuero Latón Patinado	Zamak	1/5
41.4764.3	Ø35	Bronce Envejecido	Zamak	1/20
41.4765.4	Ø35	Plata Envejecida	Zamak	1/20
41.6279.6	Ø35	Negro Forja	Zamak	1/6
41.6633.3	Ø35	Negro Mate	Zamak	1/5

dnd

Nº	Código	Medida	Espeor	Acabado	Material	
1	41.5779.3	50x50	7 mm.	Cromo Mate	Latón	1/5
1	41.5780.4	50x50	7 mm.	Cromo Brillo	Latón	1/5
1	P 41.5937.0	50x50	7 mm.	Pulido Brillo	Latón	10
1	41.5938.1	50x50	7 mm.	Blanco	Latón	1/5
1	41.5939.2	50x50	7 mm.	Negro Mate	Latón	1/5
2	41.4092.3	52x52	10 mm.	Inox Mate	Inox	1
3	41.4380.4	50x50	10 mm.	Efecto Inox	Zamak	1/10
4	41.6600.5	50x50	10 mm.	Cromo Mate	Zamak	1/5
5	41.5935.5	50x50	4 mm.	Cromo Mate	Latón	1/5
5	41.5936.6	50x50	4 mm.	Cromo Brillo	Latón	1/5
5	41.6242.4	50x50	4 mm.	PVD Antracita	Latón	1/5
5	N 41.7929.6	50x50	4 mm.	Negro Mate	Latón	1/5



BOHO Rectangular

Hierro Industrial





 1 
42.1115.2 Negro industrial

BOHO Redonda

Hierro Industrial



 1 
42.1114.1 Negro industrial

LUKE Cuadrada Mini

35 x 35 mm

Zamak



 1/10
41.4379.3 Efecto Inox
41.6646.2 Cromo Mate
41.6635.5 Negro Mate

ANDRATX Oval

55 x 40 mm

Latón



 1
41.6302.1 Óxido Corten*

* Con barniz de protección antimanchas al contacto

SOFIA

Muletilla + desbloqueo para placa
Zamak

1/20

- 41.2677.2 Pulido Brillo
- 40.1378.4 Cromo Brillo
- 41.2849.6 Cromo Mate
- 40.2118.2 Efecto Inox



SILVIA

Muletilla + desbloqueo para placa
Acero Inoxidable

1/10

- 41.3194.1 Inox Mate



ALBIN

Muletilla + desbloqueo para placa
Zamak

1

- 41.6632.2 Negro Mate
- 41.4769.1 Cuero Latón Patinado
- 41.4770.2 Bronce Envejecido
- 41.4771.3 Plata Envejecida
- 41.6278.5 Negro Forja



GINO

Muletilla + desbloqueo para placa
Zamak

1

- 41.4769.1 Cuero Latón Patinado
- 41.4770.2 Bronce Envejecido
- 41.4771.3 Plata Envejecida
- 41.6278.5 Negro Forja



MULETILLA TORNILLO VISTO

Ø41 mm
Latón

1/20

- 40.1322.4 Pulido Brillo



ELITE PIEL

Ø55 mm
Acero Inoxidable - Piel

1

- 41.4635.0 Inox Café
- 41.4636.1 Inox Marrón

Colores personalizados: gris, granate, azul, Blanco, ocre, Negro y beige.



Color café

CLOSE

Muletilla + desbloqueo
Zamak

Se adapta a cualquier picaporte unificado.

1/12

- 41.4161.2 Acero Inox



Convertor muletilla de cerraduras de bombillo
Nylon



Accesorio para convertir una cerradura de cilindro en cerradura de condena. Pueden aplicarse cuadradillos de 6x6 o 8x8 mm. No es recomendable con condenas con indicador libre/ocupado al no tener fin.

1/25

Ref. JNF

- 41.7199.2 IN20AWC

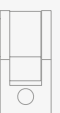

16

BÁCULO

110 x 135 mm
Latón

 1/10

- 41.5477.2** Latón Brillo
- P 41.5478.3** Cuero Latón Patinado
- P 41.5479.4** Efecto Inox

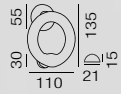

DINTEL

147 x 94 mm
Latón

 1

- P 42.0300.6** Bronce Envejecido



QUIMERA

145 x 66 mm
Latón

 1

- P 42.0304.3** Bronce Envejecido

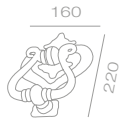

FELIPE II

74 x 100 mm
Zamak

 1/8

- 41.4983.5** Negro
- 41.4984.6** Anticuuario
- 41.4985.0** Plata vieja

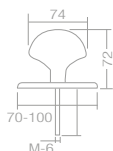

SETA-ECO

70 x 85 mm
Acero Inoxidable



2/48



41.4614.0

Inox Mate

SETA

70 x 85 mm
Latón



2/48



41.6557.4

Negro Mate

41.6647.3

Latón Mate



BOLA

70 x 70 mm
Acero Inoxidable



1



41.4697.6

Inox Mate

SFERA

DND Technical Division
70 x 80 mm
Latón

dnd



1/2



41.3081.0

Pulido Brillo

41.3082.1

Cromo Brillo

41.3083.2

Cromo Mate



ARISTA

70 x 90 mm
Latón



1



41.0302.5

Pulido Brillo

41.0303.6

Cuero



ECO

70 x 85 mm
Latón



2/48



41.2640.0

Pulido Brillo

41.3069.2

Cuero



Pomos puerta de entrada

Línea HERRAJES

DRAKO
67 x 40 mm
Latón



- 1 
- 41.6734.6 Cromo Mate
 - P** 41.6736.1 Cromo Brillo
 - P** 41.6733.5 Latón Brillo
 - P** 41.6737.2 Latón Mate
 - 41.6735.0 Negro Mate



DECO
60 x 50 mm
Latón

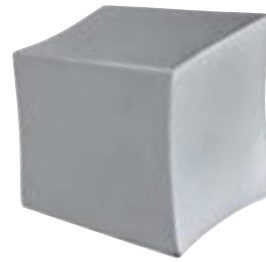

- 1/2 
- P** 41.5846.0 Cromo Brillo
 - P** 41.5847.1 Cromo Mate
 - P** 41.5844.5 Pulido Brillo
 - P** 41.5845.6 Latón Mate

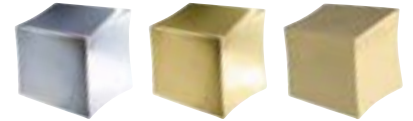

WIDE
60 x 40 mm
Latón



- 1/2 
- P** 41.5849.3 Cromo Brillo
 - P** 41.5850.4 Cromo Mate
 - P** 41.5848.2 Pulido Brillo



QUBIK-2
62 x 50 mm
Latón



- 1 
- 41.6556.3 Negro Mate
 - 41.5611.3 Efecto Inox
 - 41.5612.4 Cuero Latón Patinado



CUADRO
60 x 50 mm
Latón



- 1 
- 41.5853.0 Cromo Mate
 - P** 41.5852.6 Cromo Brillo
 - P** 41.5851.5 Pulido Brillo



938 600 536
 www.mengual.com
 comercial@mengual.com



Catálogo Herrajes



Catálogo Tiradores



Catálogo Manetas



Descubre nuestras delegaciones

